Introduction to Slope Stability and Protection

Course No: C06-006

Credit: 6 PDH

J. Paul Guyer, P.E., R.A., Fellow ASCE, Fellow AEI



Continuing Education and Development, Inc.
22 Stonewall Court
Woodcliff Lake, NJ 07677

P: (877) 322-5800
info@cedengineering.com

An Introduction to Slope Stability and Protection



Guyer Partners
44240 Clubhouse Drive
El Macero, CA 95618
(530) 758-6637
jpguyer@pacbell.net

J. Paul Guyer, P.E., R.A.

Paul Guyer is a registered mechanical engineer, civil engineer, fire protection engineer and architect with over 35 years experience in the design of buildings and related infrastructure. For an additional 9 years he was a principal advisor to the California Legislature on infrastructure and capital outlay issues. He is a graduate of Stanford University, a Fellow of the American Society of Civil Engineers and a Fellow of the Architectural Engineering Institute, and has held numerous national, state and local offices with the American Society of Civil Engineers and National Society of Professional Engineers.

This course is adapted from the *Unified Facilities Criteria* of the United States government, which is in the public domain, has unlimited distribution and is not copyrighted.

The Figures, Tables and Symbols in this document are in some cases a little difficult to read, but they are the best available. **DO NOT PURCHASE THIS COURSE IF THE FIGURES, TABLES AND SYMBOLS ARE NOT ACCEPTABLE TO YOU.**

AN INTRODUCTION TO SLOPE STABILITY AND PROTECTION

CONTENTS

- 1. INTRODUCTION**
- 2. TYPES OF FAILURES**
- 3. METHODS OF ANALYSIS**
- 4. TRANSLATIONAL FAILURE ANALYSIS**
- 5. REQUIRED SAFETY FACTORS**
- 6. EARTHQUAKE LOADING**
- 7. EFFECTS OF SOIL PARAMETERS AND GROUNDWATER ON STABILITY**
- 8. BIBLIOGRAPHY**
- 9. GLOSSARY**
- 10. SYMBOLS**

1. INTRODUCTION

1.1 SCOPE. This discussion presents methods of analyzing stability of natural slopes and safety of embankments. Diagrams are included for stability analysis, and procedures for slope stabilization are discussed. *This is not a design manual; this is an introduction only to the topic. Additionally, some of the figures, tables and symbols in this course are not particularly clear and easy to read but they are the best available.*

1.2 APPLICATIONS. Overstressing of a slope or reduction in shear strength of the soil may cause rapid or progressive displacements. The stability of slopes may be evaluated by comparison of the forces resisting failure with those tending to cause rupture along the assumed slip surface. The ratio of these forces is the factor of safety.

1.3 REFERENCE. For detailed treatment of some topics refer to the appropriate publications of the Transportation Research Board.

2. TYPES OF FAILURES

2.1 MODES OF SLOPE FAILURE. Principal modes of failure in soil or rock are (i) rotation on a curved slip surface approximated by a circular arc, (ii) translation on a planar surface whose length is large compared to the depth below ground, and (iii) displacement of a wedge-shaped mass along one or more planes of weakness. Other modes of failure include toppling of rock slopes, falls, block slides, lateral spreading, earth and mud flow in clayey and silty soils, and debris flows in coarse-grained soils. Tables 1 and 2 show examples of potential slope failure problems in both natural and man-made slopes.

2.2 CAUSES OF SLOPE FAILURE. Slope failures occur when the rupturing force exceeds resisting force.

2.2.1 NATURAL SLOPES. Imbalance of forces may be caused by one or more of the following factors:

- A change in slope profile that adds driving weight at the top, or decreases resisting force at the base. Examples include steepening of the slope or undercutting of the toe.
- An increase of groundwater pressure, resulting in a decrease of frictional resistance in cohesionless soil or swell in cohesive material.
- Groundwater pressures may increase through the saturation of a slope from rainfall or snowmelt, seepage from an artificial source, or rise of the water table.
- Progressive decrease in shear strength of the soil or rock mass caused by weathering, leaching, mineralogical changes, opening and softening of fissures, or continuing gradual shear strain (creep).
- Vibrations induced by earthquakes, blasting, or pile-driving. Induced dynamic forces cause densification of loose sand, silt, or loess below the groundwater table or collapse of sensitive clays, causing increased pore pressures. Cyclic stresses induced by earthquakes may cause liquefaction of loose, uniform, saturated sand layers.

<p>FAILURE OF THIN WEDGE, POSITION INFLUENCED BY TENSION CRACKS</p>  <p>LOW GROUNDWATER HIGH GROUNDWATER</p> <p>(1) SLOPE IN COARSE-GRAINED SOIL WITH SOME COHESION</p>	<p>WITH LOW GROUNDWATER, FAILURE OCCURS ON SHALLOW, STRAIGHT, OR SLIGHTLY CURVED SURFACE. PRESENCE OF A TENSION CRACK AT THE TOP OF THE SLOPE INFLUENCES FAILURE LOCATION. WITH HIGH GROUNDWATER, FAILURE OCCURS ON THE RELATIVELY SHALLOW TOE CIRCLE WHOSE POSITION IS DETERMINED PRIMARILY BY GROUND ELEVATION.</p> <p>ANALYZE WITH EFFECTIVE STRESSES USING STRENGTHS c' AND ϕ' FROM CD TESTS. PORE PRESSURE IS GOVERNED BY SEEPAGE CONDITION. INTERNAL PORE PRESSURES AND EXTERNAL WATER PRESSURES MUST BE INCLUDED</p>
<p>STABLE SLOPE ANGLE = EFFECTIVE FRICTION ANGLE</p>  <p>LOW GROUNDWATER HIGH GROUNDWATER</p> <p>(2) SLOPE IN COARSE-GRAINED, COHESIONLESS SOIL</p>	<p>STABILITY DEPENDS PRIMARILY ON GROUNDWATER CONDITIONS. WITH LOW GROUNDWATER, FAILURES OCCUR AS SURFACE SLOUGHING UNTIL SLOPE ANGLE FLATTENS TO FRICTION ANGLE. WITH HIGH GROUNDWATER, STABLE SLOPE IS APPROXIMATELY 1/2 FRICTION ANGLE.</p> <p>ANALYZE WITH EFFECTIVE STRESSES USING STRENGTH ϕ'. SLIGHT COHESION APPEARING IN TEST ENVELOPE IS IGNORED. SPECIAL CONSIDERATION MUST BE GIVEN TO POSSIBLE FLOW SLIDES IN LOOSE, SATURATED FINE SANDS.</p>
<p>LOCATION OF FAILURE DEPENDS ON VARIATION OF SHEAR STRENGTH WITH DEPTH</p>  <p>STRENGTH INCREASING WITH DEPTH</p> <p>STRENGTH CONSTANT WITH DEPTH</p> <p>STIFF OR HARD STRATUM</p> <p>(3) SLOPE IN NORMALLY CONSOLIDATED OR SLIGHTLY PRECONSOLIDATED CLAY</p>	<p>FAILURE OCCURS ON CIRCULAR ARCS WHOSE POSITION IS GOVERNED BY THEORY, SEE FIG. 3. POSITION OF GROUNDWATER TABLE DOES NOT INFLUENCE STABILITY UNLESS ITS FLUCTUATION CHANGES STRENGTH OF THE CLAY OR ACTS IN TENSION CRACKS.</p> <p>ANALYZE WITH TOTAL STRESSES, ZONING CROSS SECTION FOR DIFFERENT VALUES OF SHEAR STRENGTHS. DETERMINE SHEAR STRENGTH FROM UNCONFINED COMPRESSION TEST, UNCONSOLIDATED UNDRAINED TRIAXIAL TEST OR VANE SHEAR.</p>

Table 1
Analysis of Stability of Natural Soils

<p>LOCATION OF FAILURE DEPENDS ON RELATIVE STRENGTH AND ORIENTATION OF LAYERS</p>  <p>(4) SLOPE IN STRATIFIED SOIL PROFILE</p>	<p>LOCATION OF FAILURE PLANE IS CONTROLLED BY RELATIVE STRENGTH AND ORIENTATION OF STRATA. FAILURE SURFACE IS COMBINATION OF ACTIVE AND PASSIVE WEDGES WITH CENTRAL SLIDING BLOCK CHOSEN TO CONFORM TO STRATIFICATION.</p> <p>ANALYZE WITH EFFECTIVE STRESS USING c' AND ϕ' FOR FINE-GRAINED STRATA AND ϕ' FOR COHESIONLESS MATERIAL.</p>
<p>BOWL-SHAPED AREA OF LOW SLOPE (9 TO 11%) BOUNDED AT TOP BY OLD SCARP</p>  <p>FAILURE SURFACE OF LOW CURVATURE WHICH IS A PORTION OF AN OLD SHEAR SURFACE.</p> <p>(5) DEPTH CREEP MOVEMENTS IN OLD SLIDE MASS</p>	<p>STRENGTH OF OLD SLIDE MASS DECREASES WITH MAGNITUDE OF MOVEMENT THAT HAS OCCURRED PREVIOUSLY. MOST DANGEROUS SITUATION IS IN STIFF, OVER-CONSOLIDATED CLAY WHICH IS SOFTENED, FRACTURED, OR SLICKENSIDED IN THE FAILURE ZONE.</p>

Table 1 (continued)
Analysis of Stability of Natural Soils

<p>LOCATION OF FAILURE DEPENDS ON GEOMETRY AND STRENGTH OF CROSS SECTION.</p>  <p>(1) FAILURE OF FILL ON SOFT COHESIVE FOUNDATION WITH SAND DRAINS</p>	<p>USUALLY MINIMUM STABILITY OCCURS DURING PLACING OF FILL. IF RATE OF CONSTRUCTION IS CONTROLLED, ALLOW FOR GAIN IN STRENGTH WITH CONSOLIDATION FROM DRAINAGE.</p> <p>ANALYZE WITH EFFECTIVE STRESS USING c' AND ϕ' FROM CU TEST WITH PORE PRESSURE MEASUREMENT. APPLY ESTIMATED PORE PRESSURES OR PIEZOMETRIC PRESSURES. ANALYZE WITH TOTAL STRESS FOR RAPID CONSTRUCTION WITHOUT OBSERVATION OF PORE PRESSURES, USE SHEAR STRENGTH FROM UNCONFINED COMPRESSION OR UNCONSOLIDATED UNDRAINED TRIAXIAL.</p>
<p>FAILURE SURFACE MAY BE ROTATION ON CIRCULAR ARC OR TRANSLATION WITH ACTIVE AND PASSIVE WEDGES.</p>  <p>(2) FAILURE OF STIFF COMPACTED FILL ON SOFT COHESIVE FOUNDATION</p>	<p>USUALLY, MINIMUM STABILITY OBTAINED AT END OF CONSTRUCTION. FAILURE MAY BE IN THE FORM OF ROTATION OR TRANSLATION, AND BOTH SHOULD BE CONSIDERED.</p> <p>FOR RAPID CONSTRUCTION IGNORE CONSOLIDATION FROM DRAINAGE AND UTILIZE SHEAR STRENGTHS DETERMINED FROM U OR UU TESTS OR VANE SHEAR IN TOTAL STRESS ANALYSIS. IF FAILURE STRAIN OF FILL AND FOUNDATION MATERIALS DIFFER GREATLY, SAFETY FACTOR SHOULD EXCEED ONE, IGNORING SHEAR STRENGTH OF FILL. ANALYZE LONG-TERM STABILITY USING c AND ϕ FROM CU TESTS WITH EFFECTIVE STRESS ANALYSIS, APPLYING PORE PRESSURES OF GROUNDWATER ONLY.</p>
<p>ORIGINAL GROUND LINE</p> <p>CUT AT TOE</p>  <p>(3) FAILURE FOLLOWING CUT IN STIFF FISSURED CLAY</p>	<p>RELEASE OF HORIZONTAL STRESSES BY EXCAVATION CAUSES EXPANSION OF CLAY AND OPENING OF FISSURES, RESULTING IN LOSS OF COHESIVE STRENGTH.</p> <p>ANALYZE FOR SHORT TERM STABILITY USING c' AND ϕ' WITH TOTAL STRESS ANALYSIS. ANALYZE FOR LONG TERM STABILITY WITH c'_r AND ϕ'_m BASED ON RESIDUAL STRENGTH MEASURED IN CONSOLIDATED DRAINED TESTS.</p>

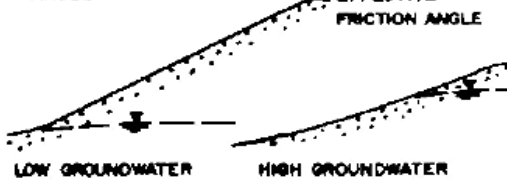
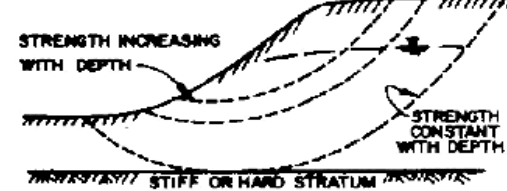
Table 2

Analysis of Stability of Cut and Fill Slopes, Conditions Varying with Time

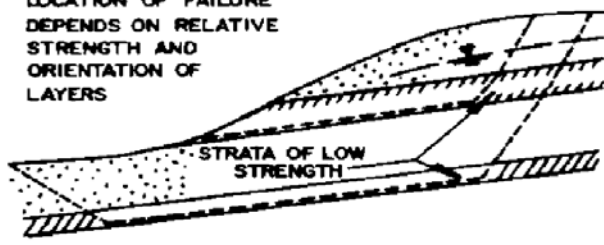
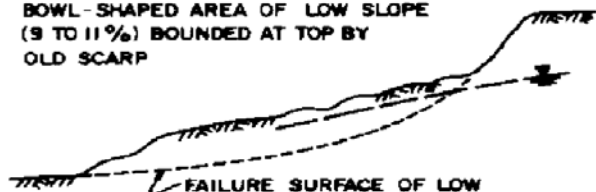
2.2.2 EMBANKMENT (FILL) SLOPES. Failure of fill slopes may be caused by one or more of the following factors:

2.2.2.1 OVERSTRESSING OF THE FOUNDATION SOIL. This may occur in cohesive soils, during or immediately after embankment construction. Usually, the short-term stability of embankments on soft cohesive soils is more critical than the long-term stability, because the foundation soil will gain strength as the pore water pressure dissipates. It may, however, be necessary to check the stability for a number of pore pressure conditions. Usually, the critical failure surface is tangent to the firm layers below the soft subsoils.

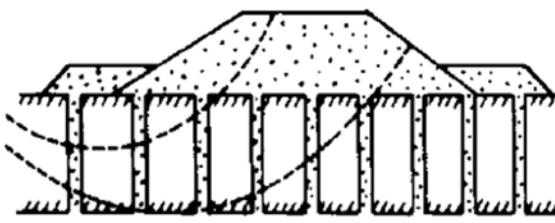
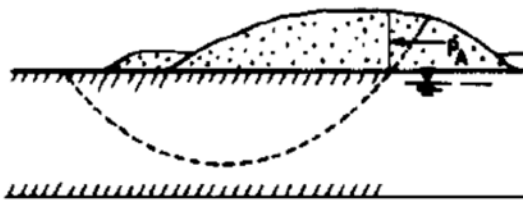
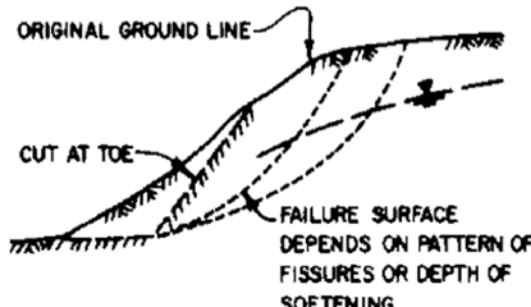
2.2.2.2 DRAWDOWN AND PIPING. In earth dams, rapid drawdown of the reservoir causes increased effective weight of the embankment soil thus reducing stability. Another potential cause of failure in embankment slopes is subsurface erosion or piping (see Chapter 6 for guidance on prevention of piping).

2.2.2.3 DYNAMIC FORCES. Vibrations may be induced by earthquakes, blasting, pile driving, etc.

2.2.2.4 EXCAVATION (CUT) SLOPES. Failure may result from one or more of the factors described in 2.2.1. An additional factor that should be considered for cuts in stiff clays is the release of horizontal stresses during excavation which may cause the formation of fissures. If water enters the fissures, the strength of the clay will decrease progressively. Therefore, the long-term stability of slopes excavated in cohesive soils is normally more critical than the short-term stability. When excavations are open over a long period and water is accessible, there is potential for swelling and loss of strength with time.

2.3 EFFECT OF SOIL OR ROCK TYPE

2.3.1 FAILURE SURFACE. In homogeneous cohesive soils, the critical failure surface usually is deep whereas shallow surface sloughing and sliding is more typical in homogeneous cohesionless soils. In non-homogeneous soil foundations the shape and location of the failure depends on the strength and stratification of the various soil types.

2.3.2 ROCK. Slope failures are common in stratified sedimentary rocks, in weathered shales, and in rocks containing platy minerals such as talc, mica, and the serpentine minerals. Failure planes in rock occur along zones of weakness or discontinuities (fissures, joints, faults) and bedding planes (strata). The orientation and strength of the discontinuities are the most important factors influencing the stability of rock slopes. Discontinuities can develop or strength can change as a result of the following environmental factors:

- Chemical weathering.
- Freezing and thawing of water/ice in joints.
- Tectonic movements.
- Increase of water pressures within discontinuities.
- Alternate wetting and drying (especially expansive shales).
- Increase of tensile stresses due to differential erosion.

3. METHODS OF ANALYSIS

3.1 TYPES OF ANALYSIS. For slopes in relatively homogeneous soil, the failure surface is approximated by a circular arc, along which the resisting and rupturing forces can be analyzed. Various techniques of slope stability analysis may be classified into three broad categories.

3.1.1 LIMIT EQUILIBRIUM METHOD. Most limit equilibrium methods used in geotechnical practice assume the validity of Coulomb's failure criterion along an assumed failure surface. A free body of the slope is considered to be acted upon by known or assumed forces. Shear stresses induced on the assumed failure surface by the body and external forces are compared with the available shear strength of the material. This method does not account for the load deformation characteristics of the materials in question. Most of the methods of stability analysis currently in use fall in this category. The method of slices, which is a rotational failure analysis, is most commonly used in limit equilibrium solutions. The minimum factor of safety is computed by trying several circles. The difference between various

approaches stems from: a) the assumptions that make the problem determinate and b) the equilibrium conditions that are satisfied. The soil mass within the assumed slip surface is divided into several slices, and the forces acting on each slice are considered. The effect of an earthquake may be considered by applying the appropriate horizontal force on the slices.

3.1.2 LIMIT ANALYSIS. This method considers yield criteria and the stress-strain relationship. It is based on lower bound and upper bound theorems for bodies of elastic - perfectly plastic materials.

3.1.3 FINITE ELEMENT METHOD. This method is extensively used in more complex problems of slope stability and where earthquake and vibrations are part of total loading system. This procedure accounts for deformation and is useful where significantly different material properties are encountered.

3.2 FAILURE CHARACTERISTICS. Table 1 shows some situations that may arise in natural slopes. Table 2 shows situations applicable to man-made slopes. Strength parameters, flow conditions, pore water pressure, failure modes, etc. should be selected as described herein. Figure 1 illustrates one method of slope analysis (“Method of Slices – Simplified Bishop Method [Circular Slip Surface]”).

Considering the equilibrium of forces in the vertical direction but neglecting the shearing forces between slices the factor of safety for moment equilibrium becomes (neglecting earthquake forces):

$$F_m = \frac{\sum_{i=1}^{i=N} [\bar{c}b_i + (W_i - u_i b_i) \tan \bar{\phi}] / M_{\alpha_i}}{\sum_{i=1}^{i=N} W_i \sin \alpha_i}$$

$$\text{WHERE } M_{\alpha_i} = \cos \alpha_i \left(1 + \frac{\tan \alpha_i \tan \bar{\phi}}{F_m} \right)$$

The above equation is solved by successive approximations. Value of M_{α_i} is obtained from Figure 1 (continued) Graph for Determination of M_{α} for an assumed value of F_m .

Example:

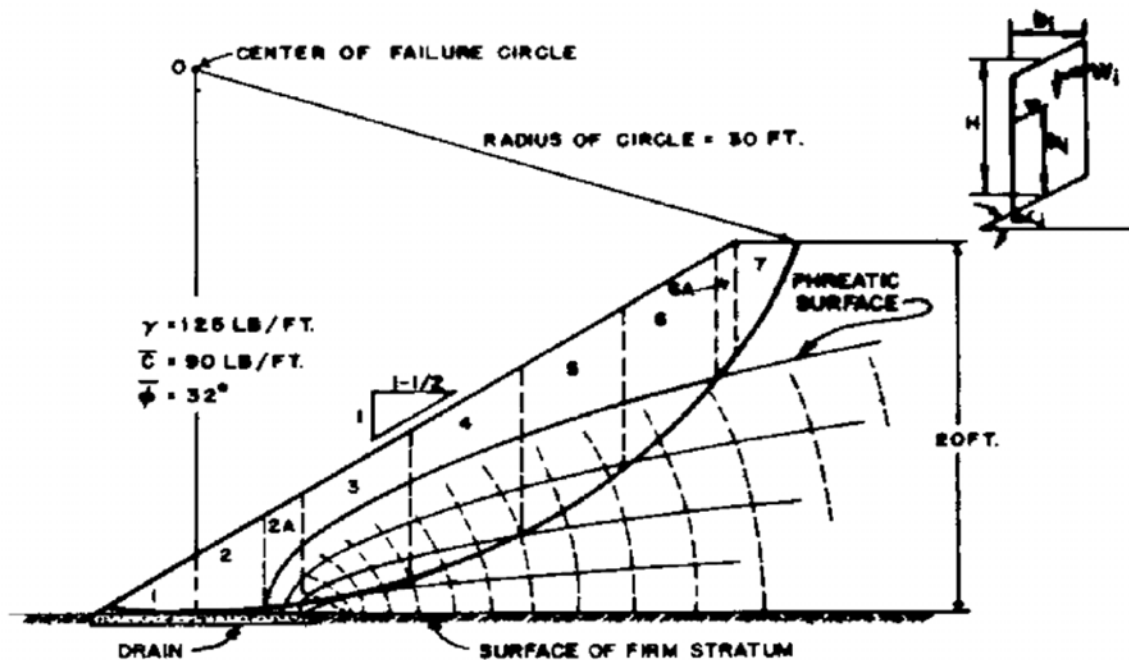

Find F_m for the trial slip circle shown.

Properties

$$\bar{c} = 90 \text{ psf}, \quad \bar{\phi} = 32^\circ, \quad \gamma = 125 \text{ PCF}$$

Slope 1-1/2 horizontal to 1 vertical.

Flow conditions as shown.

Figure 1

Method of Slices – Simplified Bishop Method (Circular Slip Surface)

Procedure (numbers in parenthesis corresponds to column in example):

1. Divide cross section into vertical slices, (1).
2. Calculate weight of each slice (W_i) using total unit weights, where b_i is the width of the slice and H is the average height of the slice, (2), (3), (4).
3. Calculate $W_i \sin \alpha_i$ for each slice, where α_i is the angle between the tangent of the failure surface and the horizontal, (5)(6).
4. Multiply the cohesive strength (\bar{c}) times the width of each slice (b_i), (7).
5. Multiply the average pore water pressure [$(u_i) = (h_i)(.0624 \text{ KSF})$] along the failure surface of each slice, times the width of each slice, (8).
6. Calculate $(W_i - u_i b_i) \tan \bar{\phi}$ for each slice, (9).
7. Add $\bar{c} b_i$ plus $(W_i - u_i b_i) \tan \bar{\phi}$ for each slice, (10).
8. Select two factors of safety (F_m), and find $M \alpha_i$ for each slice using graph below (11).
9. Divide $\bar{c} b_i + (W_i - u_i b_i) \tan \bar{\phi}$ by $M \alpha_i$ for each slice and sum resultants, (12).
10. Divide $\sum_{i=1}^{i=n} \frac{\bar{c} b_i + (W_i - u_i b_i) \tan \bar{\phi}}{M \alpha_i}$ by $\sum_{i=1}^{i=n} W_i \sin \alpha_i$ to obtain calculated F_m

Compare to F_m 's assumed in Step 8. Reiterate Steps 8, 9, and 10 until assumed F_m of Step 8 equals calculated F_m of Step 10.

11. Repeat above analysis varying center location and radius of failure circle to establish least factor of safety.

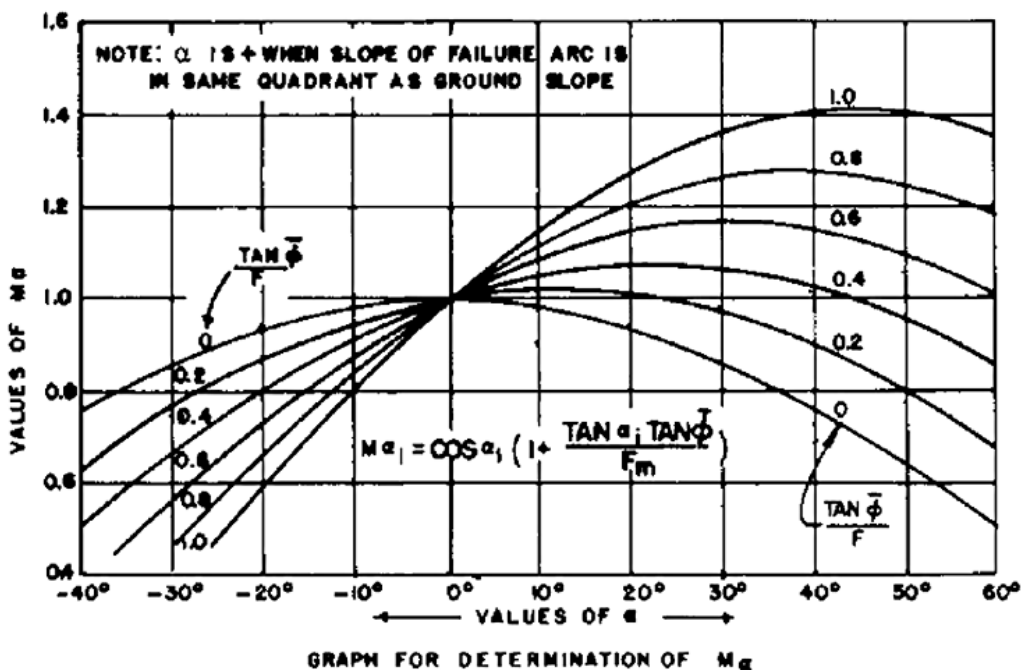

Method of Slices – Simplified Bishop Method (Circular Slip Surface)

Slice (1)	b_i (FT) (2)	H (FT) (3)	W_i (KIPS) (4)	$\sin \alpha_i$ (5)	$W_i \sin \alpha_i$ (KIPS) (6)	$\bar{c} b_i$ (KIPS) (7)	$u_i b_i$ (KIPS) (8)	$(W_i - u_i b_i) \tan \bar{\phi}$ (KIPS) (9)	$(7+9)$ (KIPS) (10)	$M \alpha_i$ F_m^c F_m^s 1.25 1.35 (11)	$(10) + (11)$ F_m^c F_m^s 1.25 1.35 (12)
1	4.5	1.6	0.9	0.03	0	0.40	0	0.55	0.95	0.97 0.97	1.00 1.00
2	3.2	4.2	1.7	0.05	0.1	0.29	0	1.05	1.35	1.02 1.02	1.30 1.30
2A	1.8	5.8	1.3	0.14	0.2	0.16	0.05	0.80	0.95	1.06 1.05	0.90 0.90
3	5.0	7.4	4.6	0.25	1.2	0.45	1.05	2.25	2.70	1.09 1.08	2.50 2.50
4	5.0	9.0	5.6	0.42	2.3	0.45	1.45	2.55	3.00	1.12 1.10	2.70 2.75
5	5.0	9.3	5.8	0.58	3.4	0.45	1.25	2.70	3.15	1.10 1.08	2.85 2.90
6	4.4	8.4	4.6	0.74	3.4	0.40	0.50	2.65	3.05	1.05 1.02	2.90 2.95
6A	0.6	6.7	0.5	0.82	0.4	0.05	0	0.30	0.35	0.98 0.95	0.35 0.40
7	3.2	3.8	1.5	0.87	1.3	0.29	0	0.95	1.25	0.93 0.92	1.30 1.35
					12.3						15.80 16.05

For assumed $F_m = 1.25$, calculated, $F_m = \frac{15.8}{12.3} = 1.29$

$F_m = 1.35$, calculated, $F_m = \frac{16.05}{12.3} = 1.31$

A trial assuming $F = 1.3$ would yield $F_m = 1.3$

Figure 1 (continued)

Method of Slices – Simplified Bishop Method (Circular Slip Surface)

3.3 SLOPE STABILITY CHARTS.

3.3.1 ROTATIONAL FAILURE IN COHESIVE SOILS ($\Phi = 0$)

3.3.1.1 For slopes in cohesive soils having approximately constant strength with depth use Figure 2 to determine the factor of safety.

3.3.1.2 For slope in cohesive soil with more than one soil layer, determine centers of potentially critical circles from Figure 3. Use the appropriate shear strength of sections of the arc in each stratum. Use the following guide for positioning the circle.

- If the lower soil layer is weaker, a circle tangent to the base of the weaker layer will be critical.
- If the lower soil layer is stronger, two circles, one tangent to the base of the upper weaker layer and the other tangent to the base of the lower stronger layer, should be investigated.
- With surcharge, tension cracks, or submergence of slope, apply corrections of Figure 4 to determine safety factor.

3.4 EMBANKMENTS ON SOFT CLAY. See Figure 5 for approximate analysis of embankment with stabilizing berms on foundations of constant strength. Determine the probable form of failure from the relationship of berm and embankment widths and foundation thickness in the top left panel of Figure 5.

4. TRANSLATIONAL FAILURE ANALYSIS. In stratified soils, the failure surface may be controlled by a relatively thin and weak layer. Analyze the stability of the potentially translating mass as shown in Figure 6 by comparing the destabilizing forces of the active pressure wedge with the stabilizing force of the passive wedge at the toe plus the shear strength along the base of the central soil mass. See Figure 7 for an example of translational failure analysis in soil and Figure 8 for an example of translational failure in rock. Jointed rocks involve

multiple planes of weakness. This type of problem cannot be analyzed by two-dimensional cross-sections.

5. REQUIRED SAFETY FACTORS. The following values should be provided for reasonable assurance of stability:

- Safety factor no less than 1.5 for permanent or sustained loading conditions.
- For foundations of structures, a safety factor no less than 2.0 is desirable to limit critical movements at the foundation edge.
- For temporary loading conditions or where stability reaches a minimum during construction, safety factors may be reduced to 1.3 or 1.25 if controls are maintained on load application.
- For transient loads, such as earthquake, safety factors as low as 1.2 or 1.15 may be tolerated.

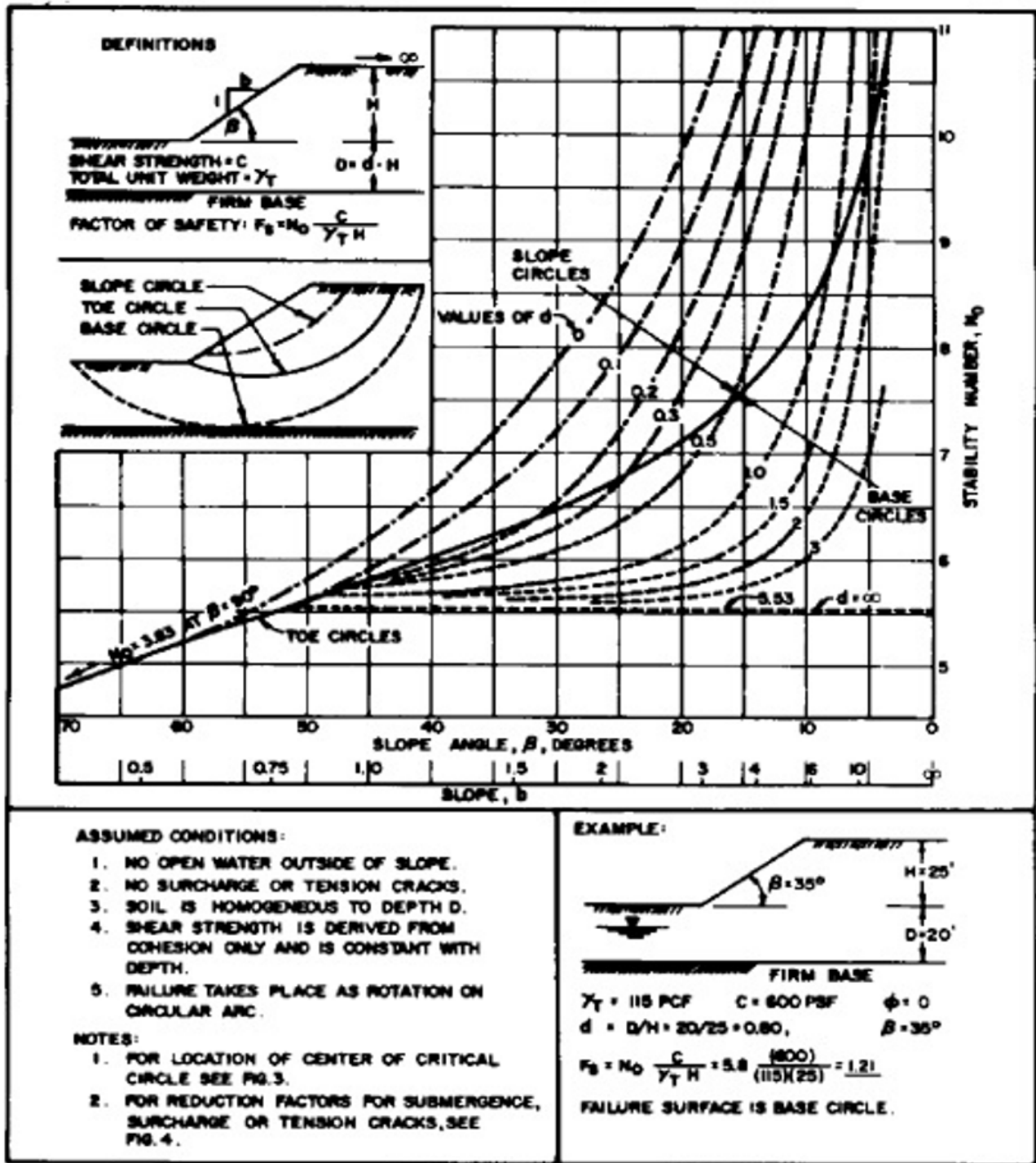

Figure 2

Stability Analysis for Slopes in Cohesive Soils, Undrained Conditions, i.e. $\Phi = 0$

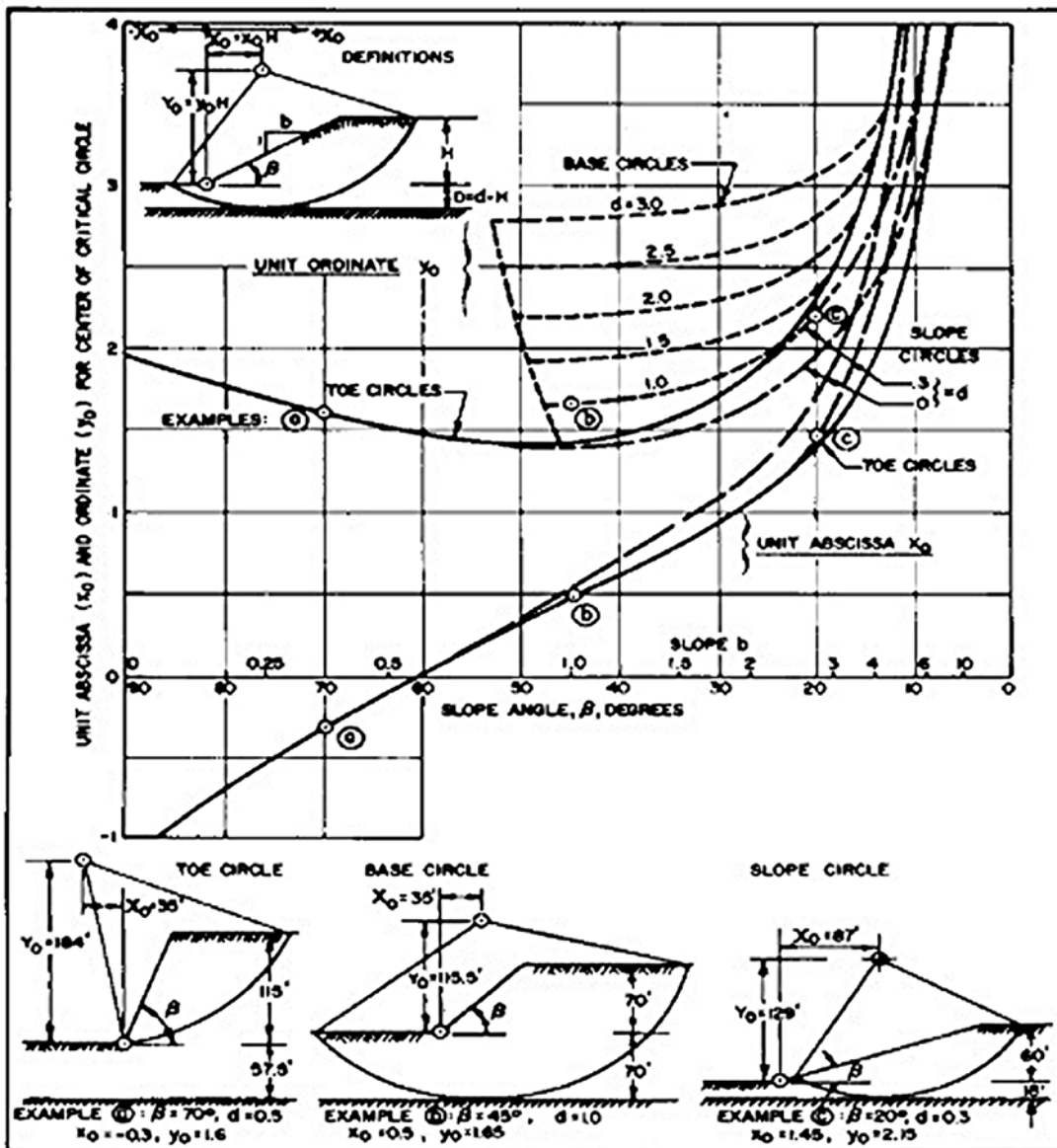

Figure 3
Center of Critical Circle, Slope in Cohesive Soil

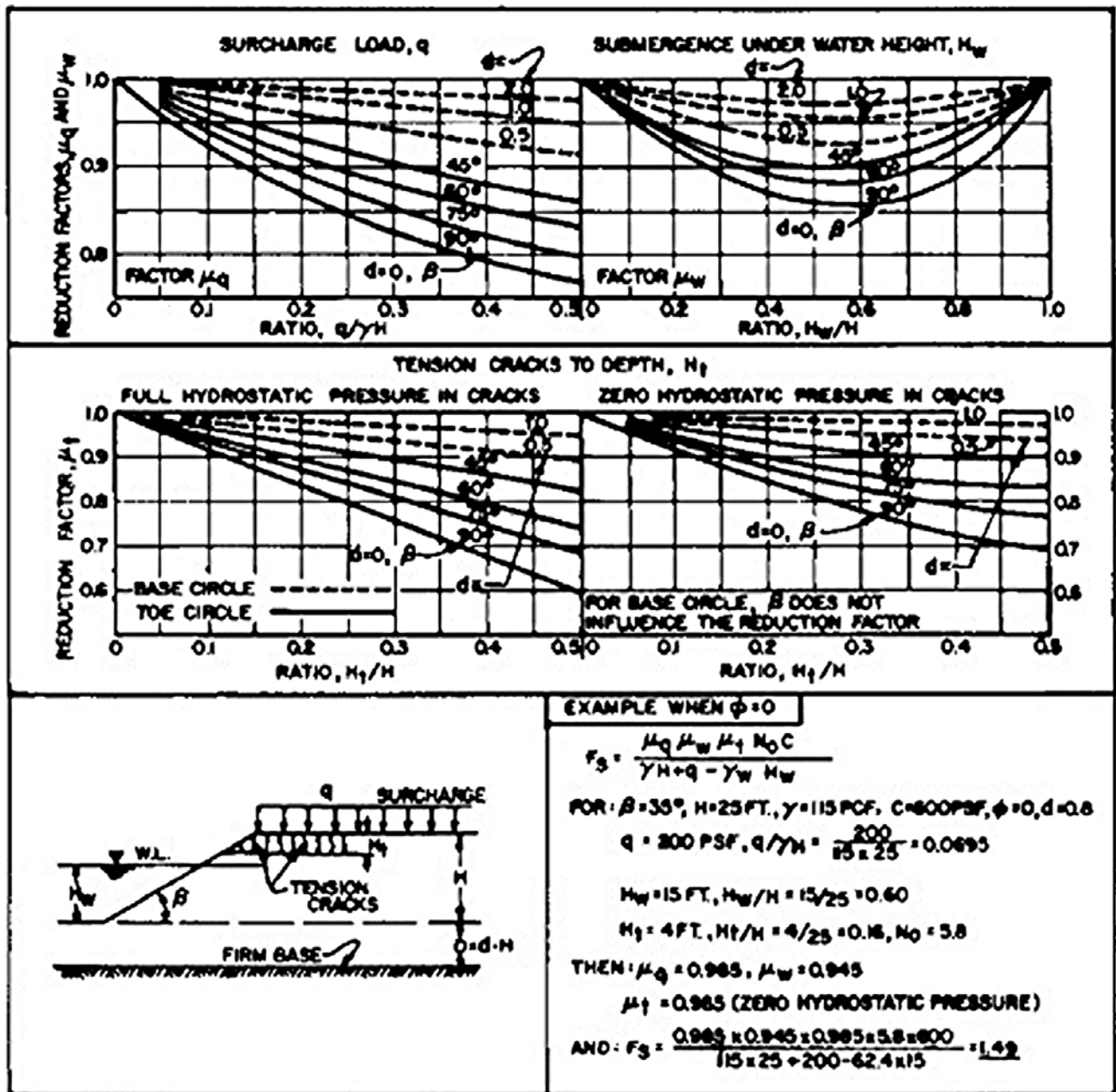

Figure 4

Influence of Surcharge, Submergence, and Tension Cracks on Stability

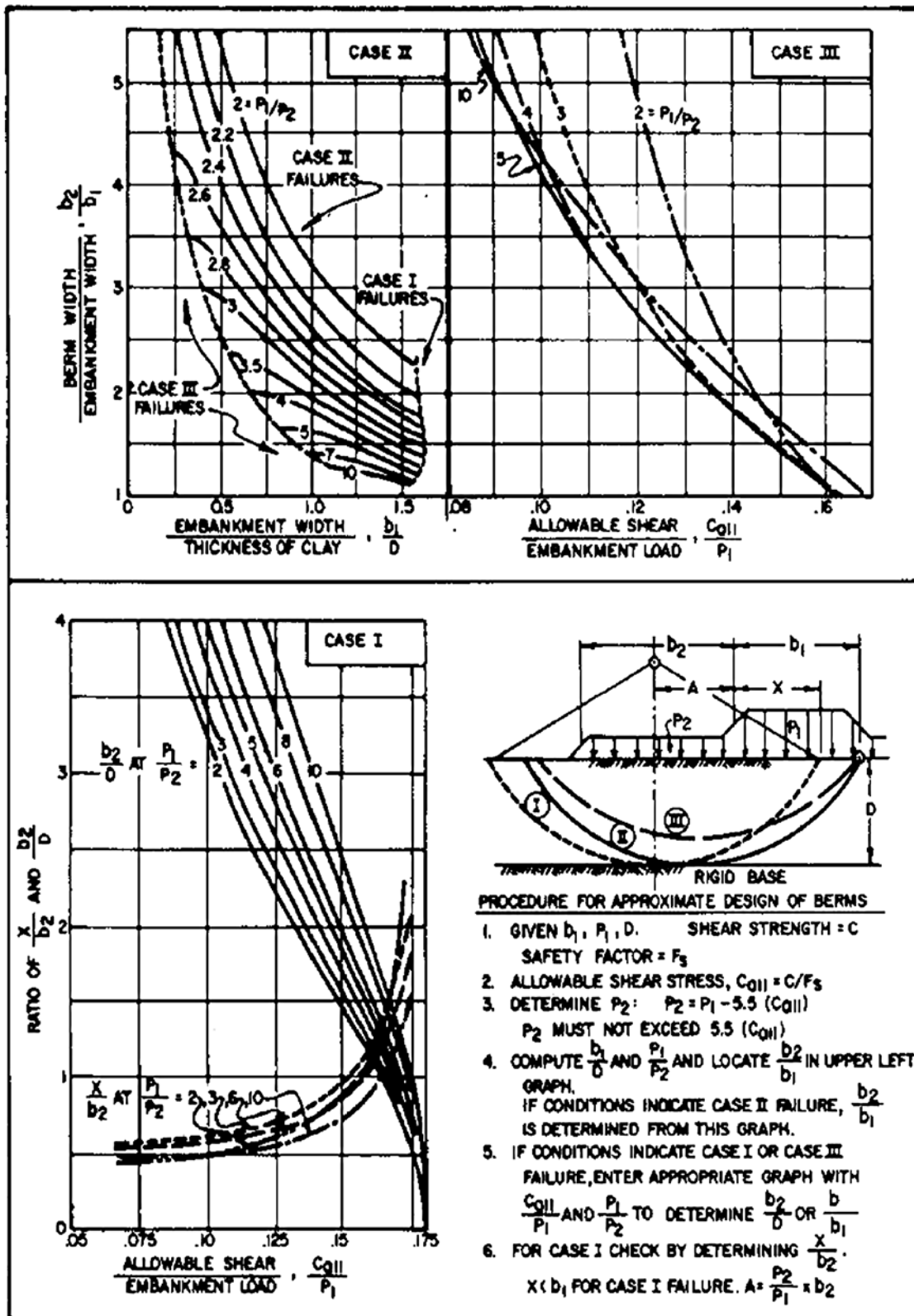

Figure 5

Design of Berms for Embankments on Soft Clays

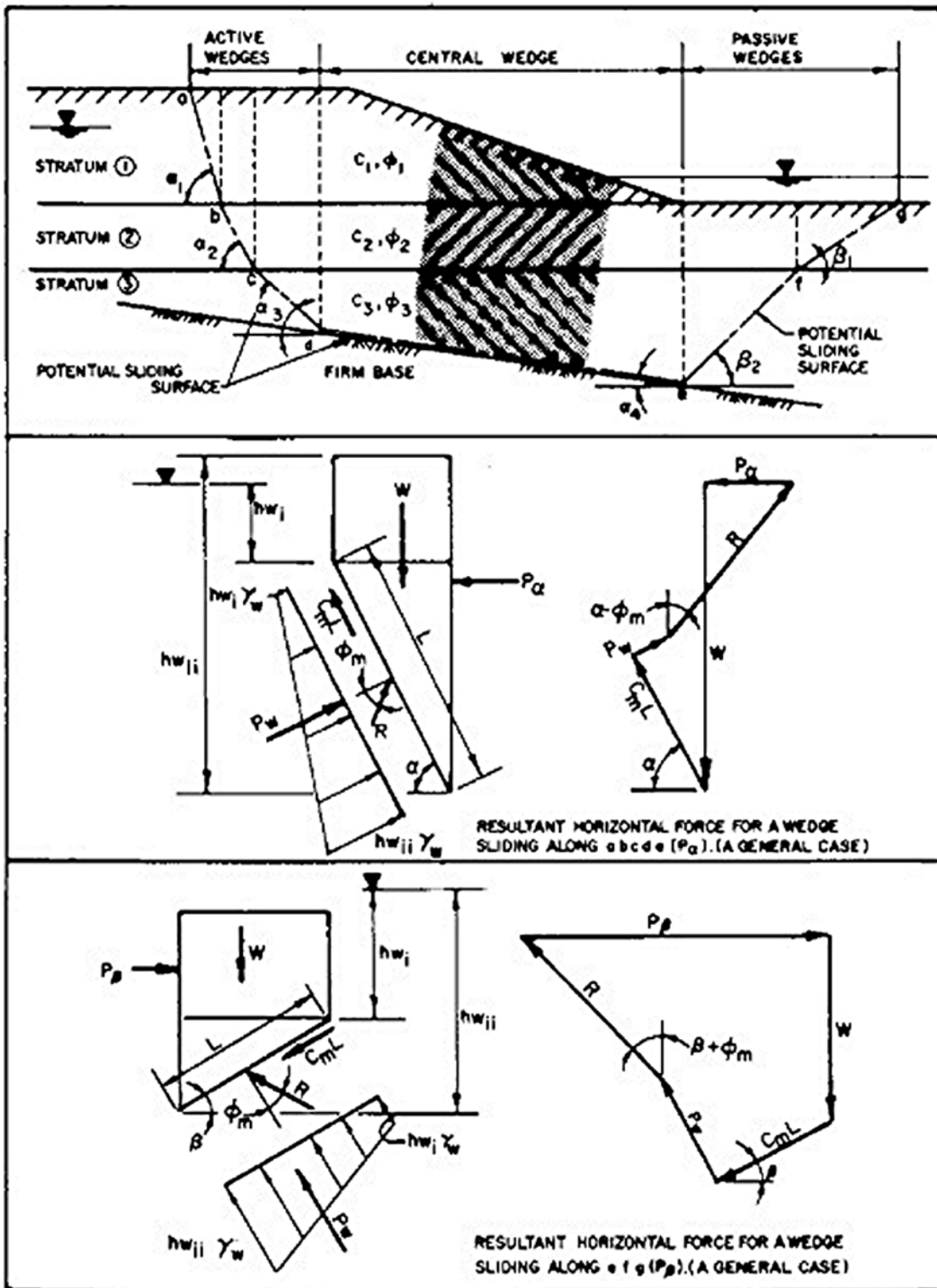

Figure 6
Stability Analysis of Translational Failure

DEFINITION OF TERMS

- P_α = RESULTANT HORIZONTAL FORCE FOR AN ACTIVE OR CENTRAL WEDGE ALONG POTENTIAL SLIDING SURFACE a b c d e .
- P_β = RESULTANT HORIZONTAL FORCE FOR A PASSIVE WEDGE ALONG POTENTIAL SLIDING SURFACE e f g .
- W = TOTAL WEIGHT OF SOIL AND WATER IN WEDGE ABOVE POTENTIAL SLIDING SURFACE.
- R = RESULT OF NORMAL AND TANGENTIAL FORCES ON POTENTIAL SLIDING SURFACE CONSIDERING FRICTION ANGLE OF MATERIAL.
- P_w = RESULTANT FORCE DUE TO PORE WATER PRESSURE ON POTENTIAL SLIDING SURFACE CALCULATED AS :

$$P_w = \left[\frac{h_{w1} + h_{w2}}{2} \right] (L)(\gamma_w)$$
- ϕ = FRICTION ANGLE OF LAYER ALONG POTENTIAL SLIDING SURFACE.
- C = COHESION OF LAYER ALONG POTENTIAL SLIDING SURFACE .
- L = LENGTH OF POTENTIAL SLIDING SURFACE ACROSS WEDGE.
- h_w = DEPTH BELOW PHREATIC SURFACE AT BOUNDARY OF WEDGE.
- γ_w = UNIT WEIGHT OF WATER.

PROCEDURES

- 1.) EXCEPT FOR CENTRAL WEDGE WHERE α IS DICTATED BY STRATIGRAPHY USE $\alpha = 45^\circ + \frac{\phi}{2}$, $\beta = 45^\circ - \frac{\phi}{2}$ FOR ESTIMATING FAILURE SURFACE.
- 2.) SOLVE FOR P_α AND P_β FOR EACH WEDGE IN TERMS OF THE SAFETY FACTOR (F_s) USING THE EQUATIONS SHOWN BELOW. THE SAFETY FACTOR IS APPLIED TO SOIL STRENGTH VALUES ($\tan \phi$ AND C).
 MOBILIZED STRENGTH PARAMETERS ARE THEREFORE CONSIDERED AS $\phi_m = \tan^{-1} \left(\frac{\tan \phi}{F_s} \right)$ AND $C_m = \frac{C}{F_s}$.

$$P_\alpha = [W - C_m L \sin \alpha - P_w \cos \alpha] \tan [\alpha - \phi_m] - [C_m L \cos \alpha - P_w \sin \alpha]$$

$$P_\beta = [W + C_m L \sin \beta - P_w \cos \beta] \tan (\beta + \phi_m) + [C_m L \cos \beta + P_w \sin \beta]$$

IN WHICH THE FOLLOWING EXPANSIONS ARE TO BE USED:

$$\tan (\alpha - \phi_m) = \frac{\tan \alpha - \frac{\tan \phi}{F_s}}{1 + \tan \alpha \frac{\tan \phi}{F_s}} \quad \tan (\beta + \phi_m) = \frac{\tan \beta + \frac{\tan \phi}{F_s}}{1 - \tan \beta \frac{\tan \phi}{F_s}}$$

- 3.) FOR EQUILIBRIUM $\sum P_\alpha = \sum P_\beta$. SUM P_α AND P_β FORCES IN TERMS OF F_s , SELECT TRIAL F_s , CALCULATE $\sum P_\alpha$ AND $\sum P_\beta$. IF $\sum P_\alpha \neq \sum P_\beta$, REPEAT. PLOT P_α AND P_β VS. F_s WITH SUFFICIENT TRIALS TO ESTABLISH THE POINT OF INTERSECTION (i.e., $\sum P_\alpha = \sum P_\beta$), WHICH IS THE CORRECT SAFETY FACTOR.
- 4.) DEPENDING ON STRATIGRAPHY AND SOIL STRENGTH, THE CENTER WEDGE MAY ACT TO MAINTAIN OR UPSET EQUILIBRIUM.
- 5.) NOTE THAT FOR $\phi = 0$, ABOVE EQUATIONS REDUCE TO:

$$P_\alpha = W \tan \alpha - \frac{C_m L}{\cos \alpha} \quad , \quad P_\beta = W \tan \beta + \frac{C_m L}{\cos \beta}$$
- 6.) THE SAFETY FACTOR FOR SEVERAL POTENTIAL SLIDING SURFACES MAY HAVE TO BE COMPUTED IN ORDER TO FIND THE MINIMUM SAFETY FACTOR FOR THE GIVEN STRATIGRAPHY.

Figure 6 (continued)
 Stability Analysis of Translational Failure

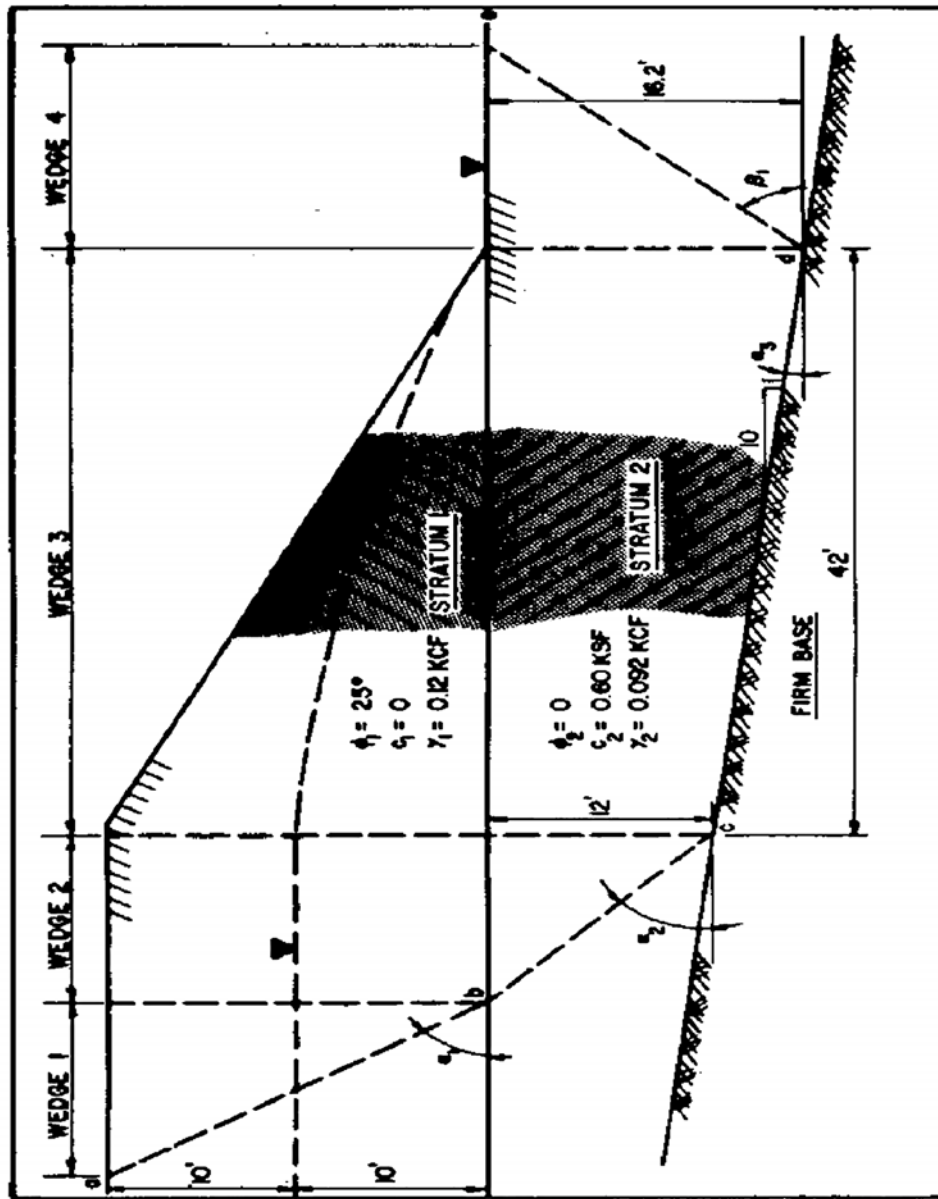

Figure 7

Example of Stability Analysis of Translational Failure

FORCES P_a

WEDGE 1: $\phi = 25^\circ, C = 0, \gamma = 0.12 \text{ KCF}$ (SLIDING SURFACE ab)
 $\alpha_1 = 45 + \phi_1/2 = 37.5^\circ$
 $W = \frac{20}{2} \times 20 \times \tan 32.5^\circ \times 0.12 = 15.29 \text{ KIPS}$
 $P_w = \left(\frac{0+10}{2}\right) (0.082) \times \left(\frac{10}{\sin 57.5^\circ}\right) = 3.68 \text{ KIPS}$
 $P_{a1} = (W - P_w \cos \alpha_1) \frac{\left(\frac{\tan \alpha_1 - \frac{c}{F_s}}{1 + \frac{\tan \alpha_1}{F_s}}\right)}{\left(1 + \frac{\tan \alpha_1}{F_s}\right)} + P_w \sin \alpha_1$
 $= (15.29 - 1.98) \frac{\left(\frac{1.57 - 0.47}{F_s}\right)}{\left(1 + \frac{0.73}{F_s}\right)} + 3.10 = \frac{(20.80 F_s - 6.26)}{F_s + 0.73} + 3.10$

WEDGE 2: $\phi = 0, C = 0.60 \text{ KSF}, \gamma = 0.092 \text{ KCF}$ (SLIDING SURFACE bc)
 $\alpha_2 = 45^\circ$
 $W = 12 \times 10 \times 0.12 + 12 \times 10 \times 0.12 + \frac{12}{2} \times 12 \times 0.092 = 35.42 \text{ KIPS}$
 $P_{a2} = W \tan \alpha_2 - \frac{cL}{\cos \alpha_2}$ (FOR $\phi = 0$)
 $= 35.42 - \frac{(0.60 \times 12)}{(0.707)} = 35.42 - \frac{14.40}{F_s}$

WEDGE 3: $\phi = 0, C = 0.60 \text{ KSF}, \gamma = 0.092 \text{ KCF}$ (SLIDING SURFACE cd)
 $\alpha_3 = \tan^{-1} 0.1 = 5.7^\circ$
 $W = \frac{20}{2} \times 42 \times 0.12 + \frac{12 + 16.2}{2} \times 42 \times 0.092 = 104.88 \text{ KIPS}$
 $P_{a3} = W \tan \alpha_3 - \frac{cL}{\cos \alpha_3}$ (FOR $\phi = 0$)
 $= [104.88 \times 0.10] - \frac{\left(\frac{0.60 \times 42}{F_s}\right)}{0.99} = 10.49 - \frac{25.71}{F_s}$

$\Sigma P_a = \frac{20.80 F_s - 6.26}{F_s + 0.73} + 49.01 - \frac{40.11}{F_s}$

FORCES P_b

WEDGE 4: $\phi = 0, C = 0.60 \text{ KSF}, \gamma = 0.092 \text{ KCF}$ (SLIDING SURFACE de)
 $\beta_1 = 45^\circ$
 $W = \frac{16.2}{2} \times 16.2 \times 0.092 = 12.07 \text{ KIPS}$
 $P_{b1} = W \tan \beta + \frac{cL}{\cos \beta}$ (FOR $\phi = 0$)
 $= 12.07 + \frac{\left(\frac{0.60 \times 16.20}{F_s}\right)}{0.707} = 12.07 + \frac{13.44}{F_s}$
 $\Sigma P_b = 12.07 + \frac{13.44}{F_s}$

Figure 7 (continued)

Example of Stability Analysis of Translational Failure

SOLVE FOR F_s , FROM $\Sigma P_a = \Sigma P_b$

F_s	ΣP_a	ΣP_b
1.0	17.4	31.5
1.1	21.7	29.7
1.2	25.3	28.3
1.3	28.5	27.0

$F_s = 1.27$

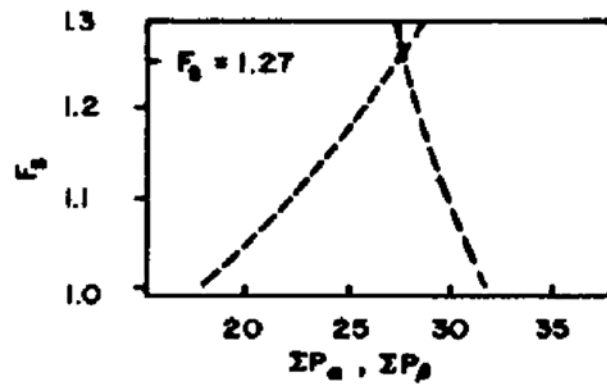

Figure 7 (continued)

Example of Stability Analysis of Translational Failure

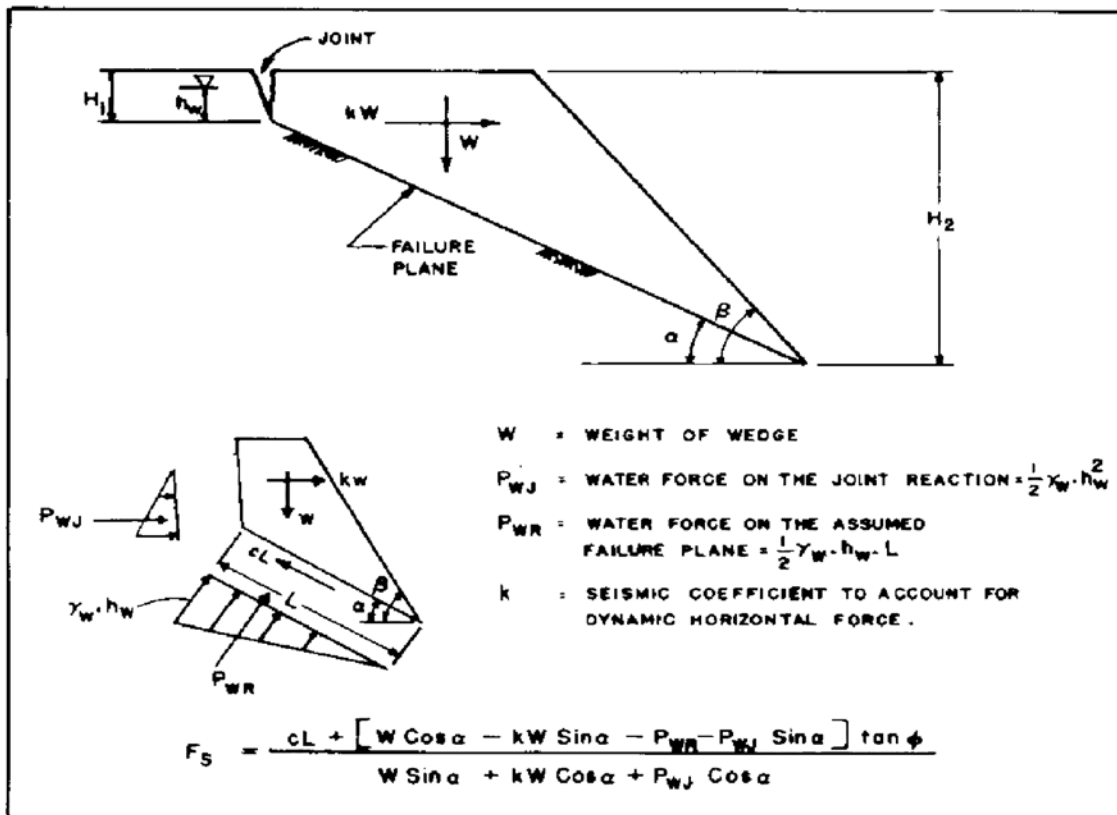

Figure 8
Stability of Rock Slope

6. EARTHQUAKE LOADING. Earthquake effects can be introduced into the analysis by assigning a disturbing force on the sliding mass equal to kW where W is the weight of the sliding mass and k is the seismic coefficient. For the analyses of stability shown in Figure 9a, $k+s,W$ is assumed to act parallel to the slope and through the center of mass of the sliding mass. Thus, for a factor of safety of 1.0:

$$Wb + k+s,Wh = FR$$

The factor of safety under an earthquake loading then becomes:

$$F+s_e = FR / (Wb + k+s,Wh)$$

To determine the critical value of the seismic efficient ($k+cs$,) which will reduce a given factor of safety for a stable static condition ($F+So$,) to a factor of safety of 1.0 with an earthquake loading ($F+Se$, = 1.0), use

$$k+cs = (b/h) (F+So, - 1) = (F+So, -1)(\sin \theta)$$

If the seismic force is in the horizontal direction and denoting such force as $k+ch$, W , then $k+ch = (F+So,-1) (\tan \theta)$. For granular, free-draining material with plane sliding surface (Figure 9b): $F+So = \tan \phi / \tan \theta$, and $k+cs = (F+So, -1)(\sin \theta)$. Based on several numerical experiments $k+ch$, may be conservatively represented as $k+ch$, [approximately] $(F+So, - 1)(0.25)$.

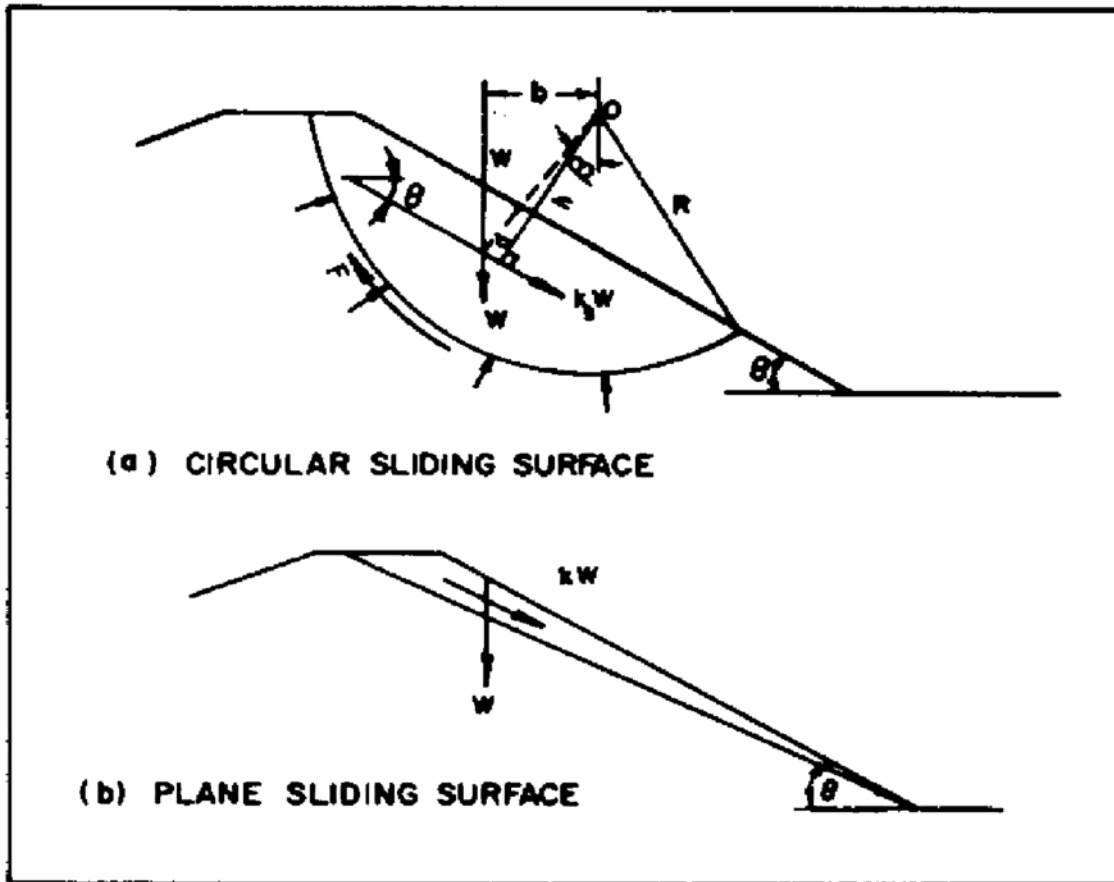

Figure 9
Earthquake Loading on Slopes

The above equations are based on several simplifying assumptions: a) failure occurs along well defined slip surface, b) the sliding mass behaves as a rigid body; c) soils are not sensitive and would not collapse at small deformation; and d) there is no reduction in soil strength due to ground shaking.

7. EFFECTS OF SOIL PARAMETERS AND GROUNDWATER ON STABILITY

7.1 INTRODUCTION. The choice of soil parameters and the methods of analyses are dictated by the types of materials encountered, the anticipated groundwater conditions, the time frame of construction, and climatic conditions. Soil strength parameters are selected

either on the basis of total stress, ignoring the effect of the pore water pressure, or on the basis of effective stress where the analysis of the slope requires that the pore water pressures be treated separately.

7.2 TOTAL VS. EFFECTIVE STRESS ANALYSIS. The choice between total stress and effective stress parameters is governed by the drainage conditions which occur within the sliding mass and along its boundaries. Drainage is dependent upon soil permeability, boundary conditions, and time.

7.2.1 TOTAL STRESS ANALYSIS. Where effective drainage cannot occur during shear, use the undrained shear strength parameters such as vane shear, unconfined compression, and unconsolidated undrained (UU or Q) triaxial compression tests. Field vane shear and cone penetration tests may be used. Assume $[\phi] = 0$. Examples where total stress analysis are applicable include:

7.2.1.1 ANALYSIS OF CUT SLOPES OF NORMALLY CONSOLIDATED OR SLIGHTLY PRECONSOLIDATED CLAYS. In this case little dissipation of pore water pressure occurs prior to critical stability conditions.

7.2.1.2 ANALYSIS OF EMBANKMENTS ON A SOFT CLAY STRATUM. This is a special case as differences in the stress-strain characteristics of the embankment and the foundation may lead to progressive failure. The undrained strength of both the foundation soil and the embankment soil should be reduced in accordance with the strength reduction factors R+E, and R+F, in Figure 10.

7.2.1.3 RAPID DRAWDOWN OF WATER LEVEL PROVIDING INSUFFICIENT TIME FOR DRAINAGE. Use the undrained strength corresponding to the overburden condition within the structure prior to drawdown.

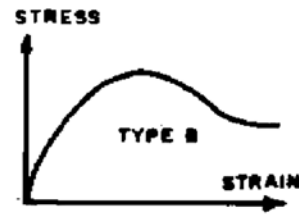
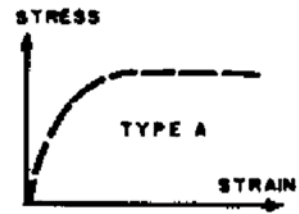
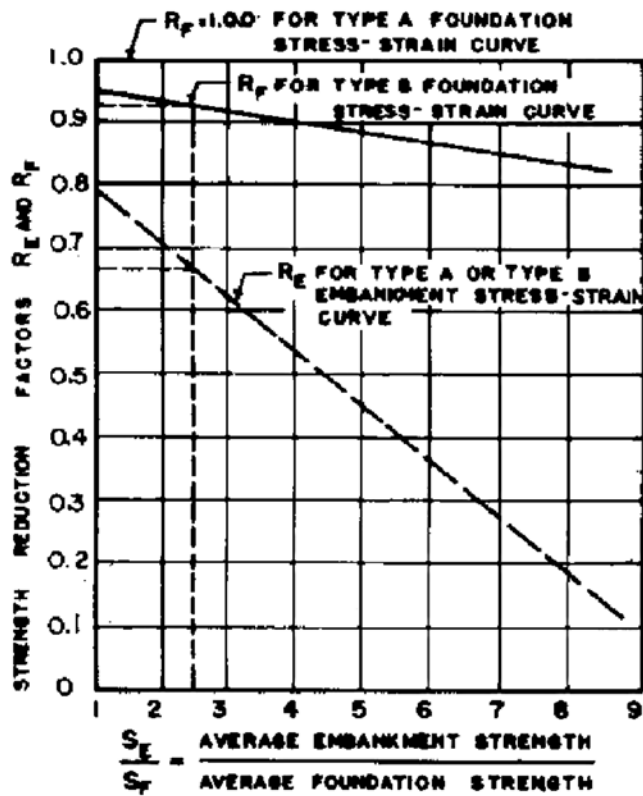

TYPE A
MEDIUM DENSE SANDS, OR NORMALLY CONSOLIDATED CLAYS

TYPE B
DENSE SANDS, OVERCONSOLIDATED OR SENSITIVE, NORMALLY CONSOLIDATED CLAYS

EXAMPLES:

FROM LAB: EMBANKMENT SOIL IS TYPE A, UNDRAINED SHEAR STRENGTH = 1000 PSF
FOUNDATION SOIL IS TYPE B, UNDRAINED SHEAR STRENGTH = 400 PSF

$$\text{THEN } \frac{S_E}{S_F} = \frac{1000}{400} = 2.5$$

$$R_E = 0.67$$

$$R_F = 0.93$$

USE UNDRAINED SHEAR STRENGTHS $S_E = 670$ AND $S_F = 372$ FOR ANALYSIS

NOTE: UNDRAINED SHEAR STRENGTH IS INDEPENDENT OF TOTAL NORMAL STRESS

Figure 10

Correction Factors R_E and R_F to Account for Progressive Failure in Embankments on Soft Clay Foundations

7.2.1.4 END-OF-CONSTRUCTION CONDITION FOR FILLS BUILT OF COHESIVE SOILS.

Use the undrained strength of samples compacted to field density and at water content representative of the embankment.

7.2.2 EFFECTIVE STRESS ANALYSIS. The effective shear strength parameters (c' , $[\phi]'$) should be used for the following cases:

7.2.2.1 LONG-TERM STABILITY OF CLAY FILLS. Use steady state seepage pressures where applicable.

7.2.2.2 SHORT-TERM OR END-OF-CONSTRUCTION CONDITION FOR FILLS BUILT OF FREE DRAINING SAND AND GRAVEL. Friction angle is usually approximated by correlation for this case.

7.2.2.3 RAPID DRAWDOWN CONDITION OF SLOPES IN PERVIOUS, RELATIVELY INCOMPRESSIBLE, COARSE-GRAINED SOILS. Use pore pressures corresponding to new lower water level with steady state flow.

7.2.2.4 LONG-TERM STABILITY OF CUTS IN SATURATED CLAYS. Use steady state seepage pressures where applicable.

7.2.2.5 CASES OF PARTIAL DISSIPATION OF PORE PRESSURE IN THE FIELD. Here, pore water pressures must be measured by piezometers or estimated from consolidation data.

7.3 EFFECT OF GROUNDWATER AND EXCESS PORE PRESSURE. Subsurface water movement and associated seepage pressures are the most frequent cause of slope instability. See Table 1 for illustrations of the effects of water on slope stability.

7.3.1 SEEPAGE PRESSURES. Subsurface water seeping toward the face or toe of a slope produces destabilizing forces which can be evaluated by flow net construction. The piezometric heads which occur along the assumed failure surface produce outward forces

which must be considered in the stability analysis. See Table 3 below and the example of Figure 1 above.

7.3.2 CONSTRUCTION PORE PRESSURES. When compressible fill materials are used in embankment construction, excess pore pressure may develop and must be considered in the stability analysis. Normally, field piezometric measurements are required to evaluate this condition.

7.3.3 EXCESS PORE PRESSURES IN EMBANKMENT FOUNDATIONS. Where embankments are constructed over compressible soils, the foundation pore pressures must be considered in the stability analysis. See top panel of Table 3 shown below.

7.3.4 ARTESIAN PRESSURES. Artesian pressures beneath slopes can have serious effects on the stability. Should such pressures be found to exist, they must be used to determine effective stresses and unit weights, and the slope and foundation stability should be evaluated by effective stress methods.

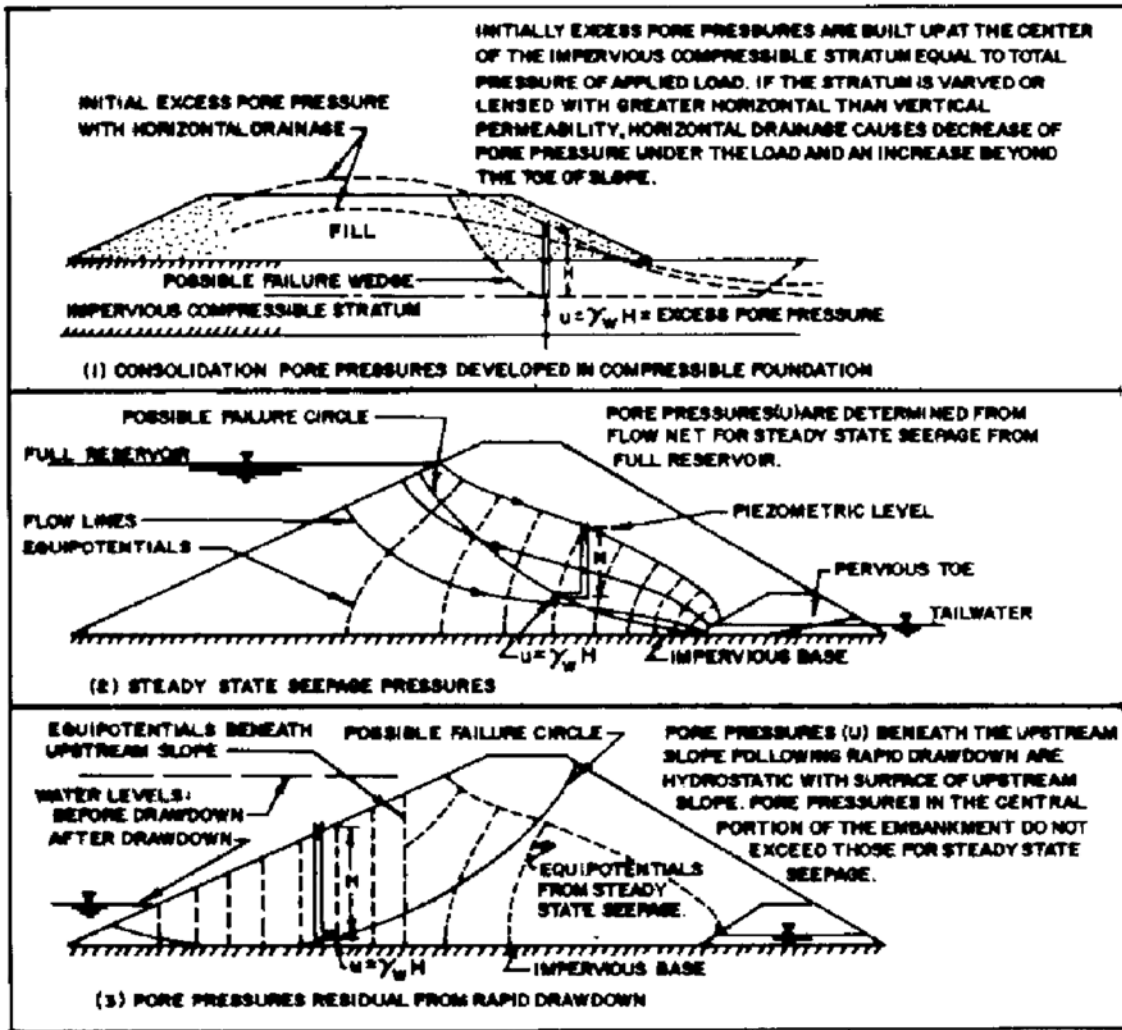

Table 3

Pore Pressure conditions for Stability Analysis of Homogeneous Embankment

7.4 STABILITY PROBLEMS IN SPECIAL MATERIALS

7.4.1 CONTROLLING FACTORS. Primary factors controlling slope stability in some special problem soils vary.

7.4.2 STRENGTH PARAMETERS.

7.4.2.1 OVERCONSOLIDATED, FISSURED CLAYS AND CLAYSHALES. See Table 2. Cuts in these materials cause opening of fissures and fractures with consequent softening and strength loss.

- **ANALYSIS OF CUT SLOPES.** For long-term stability of cut slopes use residual strength parameters c' and ϕ' from drained tests (see Chapter 3). The most reliable strength information for fissured clays is frequently obtained by back figuring the strength from local failures.
- **OLD SLIDE MASSES.** Movements in old slide masses frequently occur on relatively flat slopes because of gradual creep at depth. Exploration may show the failure mass to be stiff or hard; but a narrow failure plane of low strength with slickensides or fractures may be undetected. In such locations avoid construction which involves regrading or groundwater rise that may upset a delicate equilibrium.

7.4.2.2 SATURATED GRANULAR SOILS IN SEISMIC AREAS. Ground shaking may result in liquefaction and strength reduction of certain saturated granular soils. Empirical methods are available for estimating the liquefaction potential.

7.4.2.3 LOESS AND OTHER COLLAPSIBLE SOILS. Collapse of the structure of these soils can cause a reduction of cohesion and a rise in pore pressure. Evaluate the saturation effects with unconsolidated undrained tests, saturating samples under low chamber pressure prior to shear.

7.4.2.4 TALUS. For talus slopes composed of friable material, $[\phi]$ may range from 20 deg.

to 25 deg. If consisting of debris derived from slate or shale, $[\phi]$ may range from 20 deg. to 29 deg., limestone about 32 deg., gneiss 34 deg., and granite 35 deg. to 40 deg. These are crude estimates of friction angles and should be supplemented by analysis of existing talus slopes in the area.

7.5 SLOPE STABILIZATION

7.5.1 METHODS. See Table 4 below for a summary of slope stabilization methods. A description of some of these follows:

7.5.1.1 REGRADING PROFILE. Flattening and/or benching the slope, or adding material at the toe, as with the construction of an earth berm, will increase the stability. Analyze using the procedures above to determine the most effective regrading.

7.5.1.2 SEEPAGE AND GROUNDWATER CONTROL. Surface control of drainage decreases infiltration to potential slide area. Lowering of groundwater increases effective stresses and eliminates softening of fine-grained soils at fissures.

7.5.1.3 RETAINING STRUCTURES.

- **APPLICATION.** Walls or large diameter pilings can be used to stabilize slides of relatively small dimension in the direction of movement, or to retain steep toe slopes so that failure will not extend back into a larger mass.
- **ANALYSIS.** Retaining structures are frequently misused where active forces on wall are computed from a failure wedge comprising only a small percentage of the total weight of the sliding mass. Such failures may pass entirely beneath the wall, or the driving forces may be large enough to shear through the retaining structure. Stability analysis should evaluate a possible increase of pressures applied to a wall by an active wedge extending far back into failing mass, and possible failure on the sliding surface at any level beneath the base of the retaining structure.



Scheme	Applicable Methods	Comments
<p>1. Changing Geometry</p> <p>EXCAVATION</p> 	<ol style="list-style-type: none"> 1. Reduce slope height by excavation at top of slope. 2. Flatten the slope angle. 3. Excavate a bench in upper part of slope. 	<ol style="list-style-type: none"> 1. Area has to be accessible to construction equipment. Disposal site needed for excavated soil. Drainage sometimes incorporated in this method.
<p>2. Earth Berm Fill</p> 	<ol style="list-style-type: none"> 1. Compacted earth or rock berm placed at and beyond the toe. Drainage may be provided behind berm. 	<ol style="list-style-type: none"> 1. Sufficient width and thickness of berm required so failure will not occur below or through berm.
<p>3. Retaining Structures</p> <p>RETAINING STRUCTURES</p> 	<ol style="list-style-type: none"> 1. Retaining wall - crib or cantilever type. 2. Drilled, cast-in-place vertical piles, founded well below bottom of slide plane. Generally 18 to 36 inches in diameter and 4- to 8-foot spacing. Larger diameter piles at closer spacing may be required in some cases to mitigate failures of cuts in highly fissured clays. 	<ol style="list-style-type: none"> 1. Usually expensive. Cantilever walls might have to be tied back. 2. Spacing should be such that soil can arch between piles. Grade beam can be used to tie piles together. Very large diameter (6 feet \pm) piles have been used for deep slides.

Table 4
Methods of Stabilizing Excavation Slopes



Scheme	Applicable Methods	Comments
	<p>3. Drilled, cast-in-place vertical piles tied back with battered piles or a deadman. Piles founded well below slide plane. Generally, 12 to 30 inches in diameter and at 4- to 8-foot spacing.</p>	<p>3. Space close enough so soil will arch between piles. Piles can be tied together with grade beam.</p>
	<p>4. Earth and rock anchors and rock bolts.</p>	<p>4. Can be used for high slopes, and in very restricted areas. Conservative design should be used, especially for permanent support. Use may be essential for slopes in rocks where joints dip toward excavation, and such joints daylight in the slope.</p>
	<p>5. Reinforced earth.</p>	<p>5. Usually expensive.</p>

Table 4 (continued)
Methods of Stabilizing Excavation Slopes

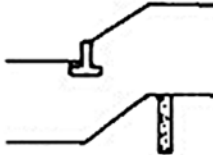
- PILES OR CAISSONS.** To be effective, the piles should extend sufficiently below the failure surface to develop the necessary lateral resistance. Figure 11 shows how the effect of the piles is considered in calculating the factor of safety. The distribution of pressure along the pile can be computed from charts shown in Figure 12. This assumes full mobilization of soil shear strength along the failure surface and should be used only when the safety factor without the piles is less than 1.4.

See Figure 13 for example computations. Note the computations shown are only for one of the many possible slip surfaces.

7.5.1.4 OTHER METHODS. Other potential procedures for stabilizing slopes include grouting, freezing, electro osmosis, vacuum pumping, and diaphragm walls.

7.6 SLOPE PROTECTION

7.6.1 SLOPE EROSION. Slopes which are susceptible to erosion by wind and rain-fall should be protected. Protection is also required for slopes subjected to wave action as in the upstream slope of a dam, or the river and canal banks along navigational channels. In some cases, provision must be made against burrowing animals.

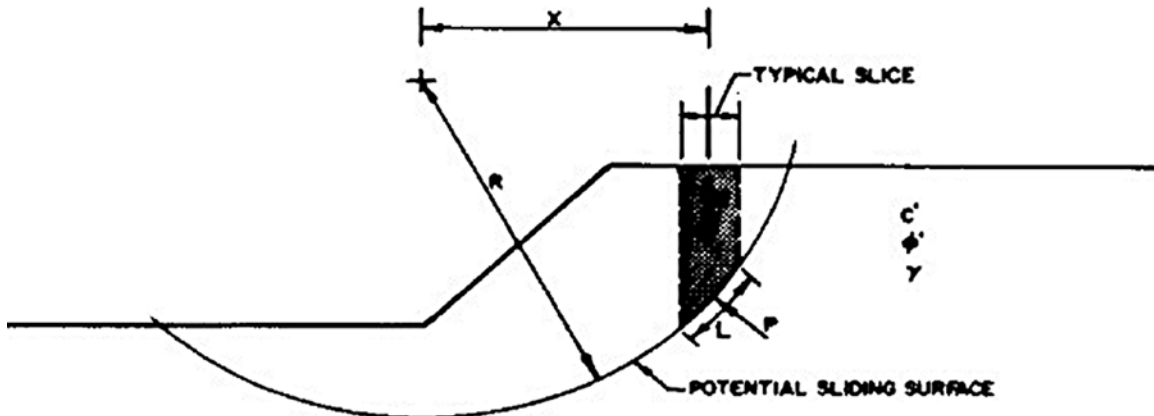

SAFETY FACTOR (F_s) FOR MOMENT EQUILIBRIUM FOR METHOD OF SLICES WITH CIRCULAR POTENTIAL SLIDING SURFACE (WITHOUT SEISMIC LOADS, SURCHARGE LOADS, OR PARTIAL SUBMERGENCE OF SLOPE) IS TYPICALLY DEFINED AS:

$$F_s = \frac{\sum c' L + \sum (P - uL) R \tan \phi'}{\sum WX}$$

WHERE:

- c' = EFFECTIVE COHESION.
- ϕ' = EFFECTIVE FRICTION ANGLE.
- W = TOTAL WEIGHT OF SLICE.
- P = TOTAL NORMAL FORCE ON BASE OF SLICE.
- L = LENGTH OF POTENTIAL SLIDING SURFACE ACROSS SLICE.
- u = AVERAGE PORE WATER PRESSURE ON POTENTIAL SLIDING SURFACE ACROSS SLICE.
- R = RADIUS OF MOMENT ARM FOR POTENTIAL SLIDING SURFACE
- X = HORIZONTAL DISTANCE FROM CENTROID OF SLICE TO CENTER OF ROTATION.

Figure 11

Influence of Stabilizing Pile on Safety Factor

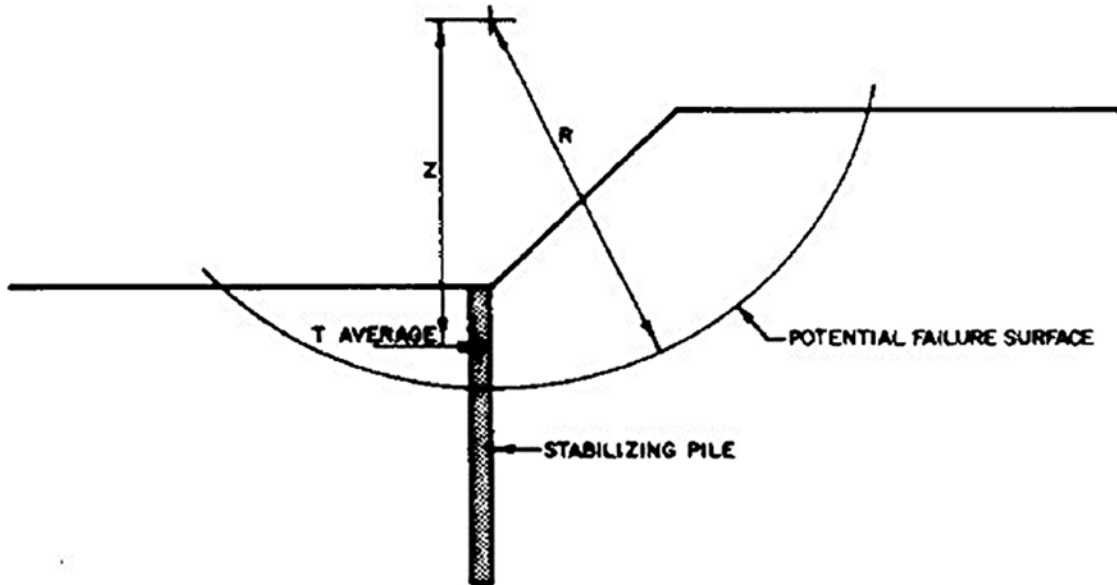

SAFETY FACTOR FOR MOMENT EQUILIBRIUM CONSIDERING THE SAME FORCES AS ABOVE PLUS THE EFFECT OF THE STABILIZING PILE IS EXPRESSED AS:

$$F_s = \frac{\Sigma c'LR + \Sigma (P-uL)R \tan \phi' + TZ}{\Sigma WX}$$

WHERE: T = AVERAGE TOTAL THRUST (PER LIN. FT., HORIZ.) RESISTING SOIL MOVEMENT.

Z = DISTANCE FROM CENTROID OF RESISTING PRESSURE (THRUST) TO CENTER OF ROTATION.

Figure 11 (continued)
Influence of Stabilizing Pile on Safety Factor

LATERAL STRESS ON PILES (σ_L)

a) SOIL WITH C AND ϕ , $\sigma_L = \bar{\sigma}_v K_q + cK_c$ — (1)

b) SOIL WITH C ONLY ($\phi=0$), $\sigma_L = \bar{\sigma}_v + cK_c$ — (2)

$\bar{\sigma}_v$ = EFFECTIVE VERTICAL STRESS AT DEPTH Z

K_q = EARTH PRESSURE COEFFICIENT FOR $\phi \neq 0$

SEE (B) AND (C) BELOW FOR DEFINITION OF K_q AND K_c

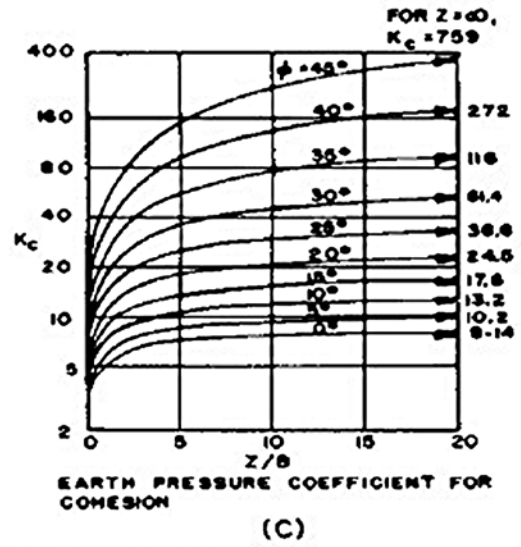
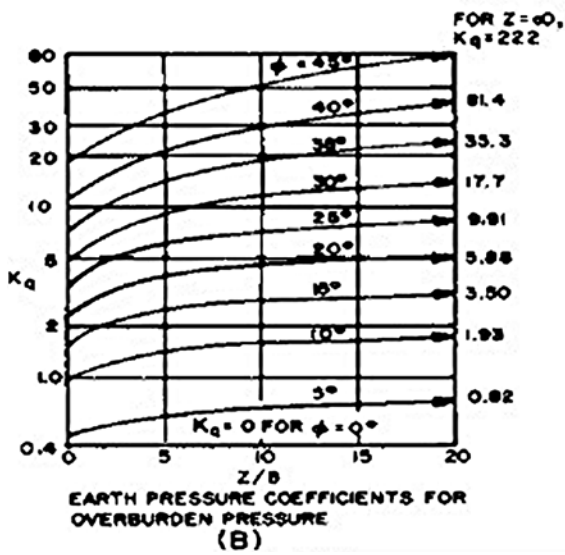
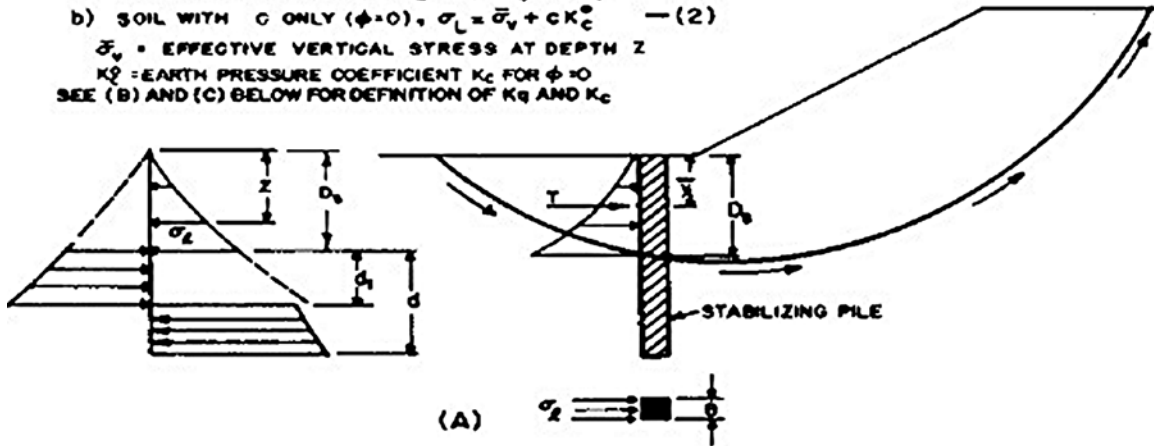
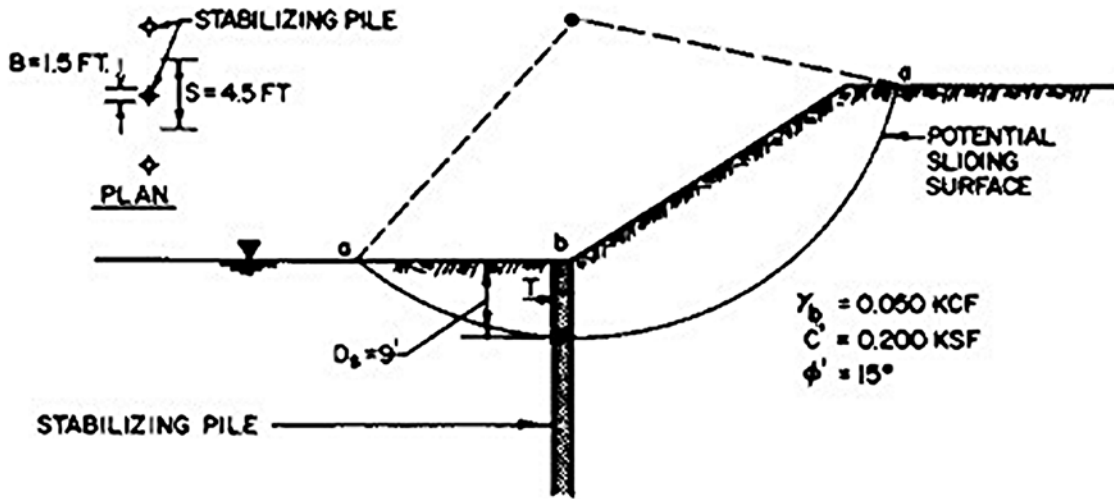

Figure 12
Pile Stabilized Slope



A. PRESSURE DIAGRAM ON STABILIZING PILE

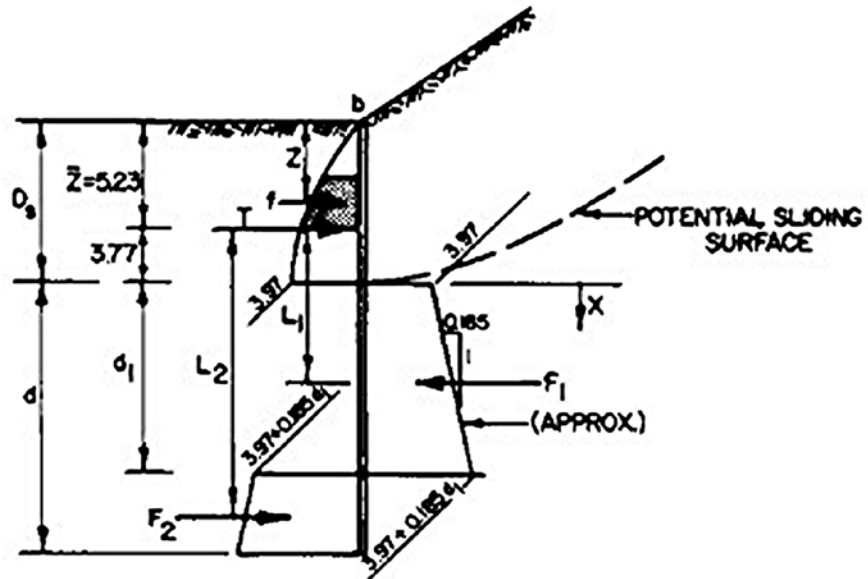

Figure 13

Example Calculation – Pile Stabilized Slopes

- B. For trial slip surface a-a compute lateral resistance, generated by presence of pile if factor of safety without piles is less than 1.4. Compute pressures using Figure 12.

$$\sigma_L = \bar{\sigma}_V K_q + cK_c \quad \text{SEE FIGURE 12 FOR DEFINITIONS}$$

Depth Below Top of Pile z (ft)	z/B	K_q	K_c	Vertical Effective Stress $\bar{\sigma}_V$ (kips/ft ²)	Lateral Resistance to Soil Movement σ_L KSF
0	0	1.5	4.0	0	0.8
3	2	2.1	10.8	0.15	2.48
6	4	2.4	12.8	0.30	3.28
9	6	2.6	14.0	0.45	3.97

- C. Compute centroid of lateral resistance (i.e., location of force T)

Depth Range	Resultant Resistance (f)		z	fz
	Over Depth Range			
0-3	$3 \left(\frac{0.8 + 2.48}{2} \right) B = 4.92B$		1.5	7.38B
3-6	8.64B		4.5	38.88B
6-9	10.87B		7.5	81.53B
	$\Sigma T = 24.43B$			127.79B

$$\bar{z} = 127.79/24.43 = 5.23 \text{ ft}$$

- D. Lateral resistance per linear foot of slope

$$T_1 = \Sigma T/S = 24.43 \times 1.5/4.5 = 8.14k$$

Note that T accounts for three dimensional condition and need not be corrected.

- E. Use T_1 in Step D and \bar{z} in Step C to compute additional stabilizing moment for evaluating safety factor including effect of piles (see Figure 11).

Figure 13 (continued)
Example Calculation – Pile Stabilized Slopes

- F. Compute σ_L at depth corresponding to $z/B = 20$ ($z = 30$) in order to compute average increase of positive resistance with depth:

$$K+q_c = 3.1, K+c_c = 16$$

$$[\sigma]_L = 3.1 \times 30 \times 0.05 + 16 \times 0.2 = 7.65 \text{ KSF}$$

Average increase in lateral resistance below D_s :

$$[\sigma]_{L+avg} = (7.65 - 3.97) / (30 - 9) = 0.185 \text{ KSF/ft}$$

Assume that the direction of lateral resistance changes at depth $d+1$ beneath failure surface, then:

- G. Calculate depth of penetration d by solving the following equations and increase d by 30% for safety:

$$T + F_{2.1} - F_{1.1} = 0 \quad (1)$$

$$F_{1.1} L_{1.1} = F_{2.1} L_{2.1} \quad (2)$$

Compute forces per unit pile width:

$$T = 24.43 \text{ k}$$

$$F_{1.1} = 3.97d_{1.1} - 0.092d_{1.1}^2$$

$$\begin{aligned} F_{2.1} &= (3.97 + 0.185d_{1.1})(d-d_{1.1}) + 0.092(d-d_{1.1})^2 \\ &= 0.092d^2 + 3.97d - 3.97d_{1.1} - 0.092d_{1.1}^2 \end{aligned}$$

- H. Use Eq (1) in Step G to calculate $d+1$ for given values of d .

$$24.43 + 0.092d^2 - 3.97d - 7.94d_{1.1} - 0.185d_{1.1}^2 = 0$$

$$d_{1.1}^2 + 42.9d_{1.1} - \frac{24.43 + 0.092d^2 + 3.97d}{0.185} = 0$$

$$\text{Let } d = 15.8', \text{ then } d_{1.1} = 11.0'$$

From Eq (2) Step G (consider each section of pressure diagram broken down as a rectangle and triangle).

Figure 13 (continued)
Example Calculation – Pile Stabilized Slopes

$$F_1 L_1 = \left[3.97 \times 11.0 \times \left(3.77 + \frac{11.0}{2} \right) \right] + \left[\frac{0.185}{2} \times 11.0^2 \times \left(3.77 + \frac{2 \times 11.0}{3} \right) \right]$$

$$= 529.1 \text{ FT-KPS}$$

$$d \cdot d_1 = 4.8$$

$$F_2 L_2 = \left[(3.97 + 0.185 \times 11.0) \times 4.8 \times \left(3.77 + 11.0 + \frac{4.8}{2} \right) \right]$$

$$+ \left[\frac{0.185}{2} \times 4.8^2 \times \left(3.77 + 11.0 + \frac{2 \times 4.8}{3} \right) \right]$$

$$= 533.2$$

$$F_1 L_1 - F_2 L_2 = -4.1$$

$$d \approx 15.8' \text{ O.K.}$$

I. Design

Increase d by 30% to obtain the practical driving depth

$$d = 15.8 \times 1.3 = 20.5'$$

LOCATE POINT OF ZERO SHEAR

$$24.43 = 3.97X + 0.092X^2$$

$$X^2 + 43.15X - 265.54 = 0$$

$$X = \frac{-43.15 \pm \sqrt{43.15^2 + 4 \times 265.54}}{2}$$

$$= 5.46'$$

COMPUTE MAXIMUM BENDING ON PILE ($B=1.5'$)

$$M_{\max} = \left[24.43 \times (3.77 + 5.46) - \left(\frac{3.97 \times 5.46^2}{2} + \frac{0.185 \times 5.46^3}{2 \times 3} \right) \right] \times 1.5$$

$$= 241.9 \text{ Kp-FT}$$

CHECK PILE SECTION VS M_{\max}

NOTES:

- Higher embedment may be required to minimize slope movements.
- Use residual shear strength parameters if appropriate.
- Analysis applicable for safety factor ≤ 1.4 without piles. Soil movement assumed to be large enough to justify assumption on rupture conditions.

Figure 13 (continued)

Example Calculation – Pile Stabilized Slopes

7.6.2 TYPES OF PROTECTION AVAILABLE. The usual protection against erosion by wind and rainfall is a layer of rock, cobbles, or sod. Protection from wave action may be provided by rock riprap (either dry dumped or hand placed), concrete pavement, precast concrete blocks, soil-cement, fabric, and wood.

7.6.2.1 STONE COVER. A rock or cobbles cover of 12" thickness is sufficient to protect against wind and rain.

7.6.2.2 SOD. Grasses suitable for a given locality should be selected with provision for fertilizing and uniform watering.

7.6.2.3 DUMPED ROCK RIPRAP. This provides the best protection against wave action. It consists of rock fragments dumped on a properly graded filter. Rock used should be hard, dense, and durable against weathering and also heavy enough to resist displacement by wave action. See Table 5 below for design guidelines.

7.6.2.4 HAND-PLACED RIPRAP. Riprap is carefully laid with minimum amount of voids and a relatively smooth top surface. Thickness should be one-half of the dumped rock riprap but not less than 12". A filter blanket must be provided and enough openings should be left in the riprap facing to permit easy flow of water into or out of the riprap.

7.6.2.5 CONCRETE PAVING. As a successful protection against wave action, concrete paving should be monolithic and of high durability. Underlying materials should be pervious to prevent development of uplift water pressure. Use a minimum thickness of 6". When monolithic construction is not possible, keep the joints to a minimum and sealed. Reinforce the slab at mid depth in both directions with continuous reinforcement through the construction joints. Use a steel area in each direction equal to 0.5% of the concrete area.

7.6.2.6 GABIONS. Slopes can be protected by gabions.

Table 5

Thickness and Gradation Limits of Dumped Riprap

Slope	Nominal thickness, inches	Gradation, percentage of stones of various weights, pounds (1)			
		Maximum size	40 to 50% greater than	50 to 60% from-to	0 to 10% less than (2)
3:1	30	2,500	1,250	75 – 1,250	75
2:1	36	4,500	2,250	100 – 2,250	100

(1) Sand and rock dust shall be less than 5%, by weight, of the total riprap material

(2) The percentage of this size material shall not exceed an amount which will fill the voids in larger rock.

8. BIBLIOGRAPHY

American Society of Photogrammetry, Manual of Photo Interpretation, Washington, D. C., 1960.

ASTM STP 447, Determination of the In Situ Modulus of Deformation of Rock, Symposium, Denver, February 2-7, 1969.

Ash, J. L. et al., Improved Subsurface Investigation for Highway Tunnel Design and Construction, Vol. 1, Subsurface Investigation System Planning, FHWA, May 1974.

Burmister, D. M., Physical, Stress-Strain, and Strength Responses of Granular Soils, ASTM Spec. Pub. No. 322, ASTM, Philadelphia, pp 67-97, 1962.

Cedergren, H., Seepage, Drainage and Flow Nets, McGraw-Hill Book Co., Inc., New York, 1967.

Chen, W. F., Limit Analysis and Soil Plasticity, Elsevier Scientific Publishing Co., New York, 1975.

Dallaire, G., Controlling Erosion and Sedimentation at Construction Sites, Civil Engineering, ASCE, pp 73-77, 1976.

Foster, C. R. and Ahlvin, P. G., Stresses and Deflections Induced by Uniform Circular Load, Highway Research Board Proceedings, Highway Research Board, Washington, D. C., 1954.

Harr, M. E., Groundwater and Seepage, McGraw-Hill Book Co., Inc., New York, 1962.

Hoek, E. and Bray, J. W., Rock Slope Engineering, 2nd Edition, The Institute of Mining and Metallurgy, London, 1977.

Menard, L. F., Interpretation and Application of Pressuremeter Test Results, Soils-Soils, Vol. 26, pp 1-43, 1975.

Mooney, H. M., Handbook of Engineering Seismology, Bison Instruments, Inc., Minneapolis, MN., 1973.

Noorany, I. and Gizienski, S. F., Engineering Properties of Submarine Soils, A State-of-the-Art Review, Journal of Soil Mechanics and Foundation Division, ASCE, Vol. 96, No. SM5, 1970.

Peck, R. B., Stability of Natural Slopes, Journal of Soil Mechanics and Foundation Division, ASCE, Vol. 93, No. SM4, 1967.

Poulos, N. C. and Davis, E. H., Elastic Solutions for Soil and Rock Mechanics, John Wiley & Sons, Inc., New York, 1974.

Seed, H. B., A Method for Earthquake Resistant Design of Earth Dams, Journal of the Soil Mechanics and Foundation Division, ASCE, Vol. 92, No. SM1, 1966.

Seed, H. B., Makdisi, F. I. and De Alba, P., Performance of Earthdams During Earthquakes, Journal of the Geotechnical Engineering Division, ASCE, Vol. 104, No. GT7, 1978.

Skempton, A. W., and Hutchinson, J., Stability of Natural Slopes and Embankment Foundations, State-of-the-Art Paper, Proceedings, Seventh International Conference Soil Mechanics Foundation Engineering, Mexico, pp 291-340, 1969.

Soil Conservation Service, USDA, A Comprehensive System, 7th Approximation, U.S. Government Printing Office, Washington, D. C. p. 265, 1960, and supplement 1967, 1968, and 1970.

Sowers, C. F., Shallow Foundations, Foundation Engineering, Leonards, Editor, McGraw-Hill Book Co., Inc., New York, Chapter 6, 1962.

Stagg, K. G., Insitu Tests on the Rock Mass, Rock Mechanics in Engineering Practice, Stagg and Zienkiewicz, Editors, John Wiley and Sons, New York, Chapter 5, 1969.

Terzaghi, K., Varieties of Submarine Slope Failures, Proceedings, Eighth Texas Conference on Soil Mechanics and Foundation Engineering, 1956.

Terzaghi, K., Stability of Steep Slopes on Hard, Unweathered Rock, Geotechnique, Vol. 12, No. 4, 1962.

Transportation Research Record 581: Innovations in Subsurface Exploration of Soils, Transportation Research Board, 1976.

Underwood, L. B., Exploration and Geologic Prediction for Underground Works, Subsurface Exploration for Underground Excavation and Heavy Construction, ASCE, New York, pp 65-83, 1974.

U.S.G.S., Earth Science Information in Land-Use Planning –Guidelines for Earth Scientists and Planners, Geological Survey Circular No. 721, U. S. Geological Survey, Fairfax, VA., 1976.

9. GLOSSARY

Activity of Clay - The ratio of plasticity index to percent by weight of the total sample that is smaller than 0.002 mm in grain size. This property is correlated with the type of clay material.

Anisotropic Soil - A soil mass having different properties in different directions at any given point referring primarily to stress-strain or permeability characteristics.

Capillary Stresses - Pore water pressures less than atmospheric values produced by surface tension of pore water acting on the meniscus formed in void spaces between soil particles.

Clay Size Fraction - That portion of the soil which is finer than 0.002 mm, not a positive measure of the plasticity of the material or its characteristics as a clay.

Desiccation - The process of shrinkage or consolidation of the fine-grained soil produced by increase of effective stresses in the grain skeleton accompanying the development of capillary stresses in the pore water.

Effective Stress - The net stress across points of contact of soil particles, generally considered as equivalent to the total stress minus the pore water pressure.

Equivalent Fluid Pressure - Horizontal pressures of soil, or soil and water, in combination, which increase linearly with depth and are equivalent to those that would be produced by a heavy fluid of a selected unit weight.

Excess Pore Pressures - That increment of pore water pressures greater than hydro-static values, produced by consolidation stresses in compressible materials or by shear strain.

Exit Gradient - The hydraulic gradient (difference in piezometric levels at two points divided by the distance between them) near an exposed surface through which seepage is moving.

Flow Slide - Shear failure in which a soil mass moves over a relatively long distance in a fluid-like manner, occurring rapidly on flat slopes in loose, saturated, uniform sands, or in highly sensitive clays.

Hydrostatic Pore Pressures - Pore water pressures or groundwater pressures exerted under conditions of no flow where the magnitude of pore pressures increase linearly with depth below the ground surface.

Isotropic Soil - A soil mass having essentially the same properties in all directions at any given point, referring directions at any given point, referring primarily to stress-strain or permeability characteristics.

Normal Consolidation - The condition that exists if a soil deposit has never been subjected to an effective stress greater than the existing overburden pressure, and if the deposit is completely consolidated under the existing overburden pressure.

Overconsolidation - The condition that exists if a soil deposit has been subjected to an effective stress greater than the existing overburden pressure.

Piezometer - A device installed for measuring the pressure head of pore water at a specific point within the soil mass.

Piping - The movement of soil particles as the result of unbalanced seepage forces produced by percolating water, leading to the development of boils or erosion channels.

Plastic Equilibrium - The state of stress of a soil mass that has been loaded and deformed to such an extent that its ultimate shearing resistance is mobilized at one or more points.

Positive Cutoff - The provision of a line of tight sheeting or a barrier of impervious material extending downward to an essentially impervious lower boundary to intercept completely the path of subsurface seepage.

Primary Consolidation - The compression of the soil under load that occurs while excess pore pressures dissipate with time.

Rippability - The characteristic of dense and rocky soils that can be excavated without blasting after ripping with a rock rake or ripper.

Slickensides - Surfaces with a soil mass which have been smoothed and striated by shear movements on these surfaces.

Standard Penetration Resistance - The number of blows of a 140-pound hammer, falling 30 inches, required to advance a 2-inch O.D., split barrel sampler 12 inches through a soil mass.

Total Stress - At a given point in a soil mass and equals the sum of the net stress across contact points of the soil particles (effective stress) plus the pore water pressure at that point.

Underconsolidation - The condition that exists if a soil deposit is not fully consolidated under the existing overburden pressure and excess hydrostatic pore pressures exist within the material.

Varved Silt or Clay - A fine-grained glacial lake deposit with alternating thin layers of silt or fine sand and clay, formed by variations in sedimentation from winter to summer during the year.

10. SYMBOLS

<u>Symbol</u>	<u>Designation</u>
A	Cross-sectional area.
A+c,	Activity of fine-grained soil.
a+v,	Coefficient of compressibility.
B,b	Width in general; or narrow dimension of a foundation unit.
CBR	California Bearing Ratio.

C+c,	Compression index for virgin consolidation.
CD	Consolidated-drained shear test.
C+r,	Recompression index in reconsolidation.
C+s,	Swelling index.
CU	Consolidated-undrained shear test.
C+u,	Coefficient of uniformity of grain size curve.
C+z,	Coefficient of curvation of gradation curve.
C+[alpha],	Coefficient of secondary compression.
c	Cohesion intercept for Mohr's envelop of shear strength based on total stresses.
c'	Cohesion intercept for Mohr's envelope of shear strength based on effective stresses.
c+h,	Horizontal coefficient of consolidation.
c+v,	Vertical coefficient of consolidation.
D,d Depth,	diameter, or distance.
D+r,	Relative density.
D+10,	Effective grain size of soil sample; 10% by dry weight of sample is smaller than this grain size.
D+5,, D+60,	Grain size division of a soil sample.
D+85,	percent of dry weight smaller than this grain size is indicated by subscript.
E	Modulus of elasticity of structural material.
E+s,	Modulus of elasticity or "modulus of deformation" of soil.
e	Void ratio.
e+f,	Final void ratio reached in loading phase of consolidation test.
e+o,	Initial void ratio in consolidation test generally equal to natural void in situ.

e+r,	Void ratio existing at the start of rebound in a consolidation test.
F	Shape factor describing the characteristics of the flow field in underseepage analysis.
F+s,	Safety factor in stability or shear strength analysis.
G	Specific gravity of solid particles in soil sample, or shear modulus of soil.
H,h	In general, height or thickness. For analysis of time rate of consolidation, H is the maximum vertical dimension of the drainage path for pore water.
h+c,	Capillary head formed by surface tension in pore water.
H+t,	Depth of tension cracks or total thickness of consolidating stratum or depth used in computing loads on tunnels.
H+w,	Height of groundwater or of open water above a base level.
I	Influence value for vertical stress produced by superimposed load, equals ratio of stresses at a point in the foundation to intensity of applied load.
i	Gradient of groundwater pressures in underseepage analysis.
K+A,	Coefficient of active earth pressures.
K+p,	Coefficient of passive earth pressures.
K+v,	Modulus of subgrade reaction for bearing plate or foundation of width b.
K+v*,	Modulus of subgrade reaction for 1 ft square bearing plate at ground surface.
k	Coefficient of permeability in general.
k+H,	Coefficient of permeability in horizontal direction.
k+m,	Mean coefficient of permeability of anisotropic subsoil.
ksf	Kips per sq ft pressure intensity.
ksi	Kips per sq in pressure intensity.
k+V,	Coefficient of permeability in vertical direction.
L,1	Length in general or longest dimension of foundation unit.

LI	Liquidity index.
LL	Liquid limit.
$m+v$,	Coefficient of volume compressibility in consolidation test.
n	Porosity of soil sample.
$n+d$,	Number of equipotential drops in flow net analysis of underseepage.
$n+e$,	Effective porosity, percent by volume of water drainable by gravity in total volume of soil sample.
$n+f$,	Number of flow paths in flow net analysis of underseepage.
OMC	Optimum moisture content of compacted soil.
$P+A$,	Resultant active earth force.
$P+AH$,	Component of resultant active force in horizontal direction.
ρ	Density in pounds per cubic foot.
$P+c$,	Preconsolidation stress.
$P+h$,	Resultant horizontal earth force.
$P+o$,	Existing effective overburden pressure acting at a specific height in the soil profile or on a soil sample.
PI	Plasticity index.
PL	Plastic limit.
$P+P$,	Resultant passive earth force.
$P+PH$,	Component of resultant passive earth force in horizontal direction.
$P+v$,	Resultant vertical earth force.
$P+w$,	Resultant force of water pressure.
p	Intensity of applied load.
q	Intensity of vertical load applied to foundation unit.

q+u,	Unconfined compressive strength of soil sample.
q+ult,	Ultimate bearing capacity that causes shear failure of foundation unit.
R,r	Radius of pile, caisson well or other right circular cylinder.
R+o,	Radius of influence of a well, distance from the well along a radial line to the point where initial groundwater level is unaltered.
r+e,	Effective radius of sand drain.
r+s,	Radius of smear zone surrounding sand drain.
r+w,	Actual radius of sand drain.
S	Percent saturation of soil mass.
SI	Shrinkage index.
SL	Shrinkage limit.
S+t,	Sensitivity of soil, equals ratio of remolded to undisturbed shear strength.
s	Shear strength of soil for a specific stress or condition in situ, used instead of strength parameters c and $[\phi]$.
T+o,	Time factor for time at end of construction in consolidation analysis for gradual loading.
T+v,	Time factor in consolidation analysis for instantaneous load application.
tsf	Tons per sq ft pressure intensity.
t,t+1, t+2,,t+n, to the points 1, 2, or n.	Time intervals from start of loading
t+50,,t+100,	Time required for a percent consolidation to be completed indicated by subscript
U	Resultant force of pore water or groundwater pressures acting on a specific surface within the subsoils.
U	Average degree of consolidation at any time.
u	Intensity of pore water pressure.
UU	Unconsolidated-undrained shear test.

$V+a$,	Volume of air or gas in a unit total volume of soil mass.
$V+s$,	Volume of solids in a unit total volume of soil mass.
$V+v$,	Volume of voids in a unit total volume of soil mass.
$V+w$,	Volume of water in a unit total volume of soil mass.
$W+s$,	Weight of solids in a soil mass or soil sample.
$W+t$,	Total weight of soil mass or soil sample.
$W+w$,	Weight of water in a soil mass or soil sample.
w	Moisture content of soil.
$[\gamma]+D$,	Dry unit weight of soil
$[\gamma]+MAX$,	Maximum dry unit weight of soil determined from moisture content dry unit weight curve.
$[\gamma]+SAT$,	Saturated unit weight of soil.
$[\gamma]+SUB$,	$[\gamma]+b$, Submerged (buoyant) unit weight of soil mass.
$[\gamma]+T$,	Wet unit weight of soil above the groundwater table.
$[\gamma]+W$,	Unit weight of water, varying from 62.4 pcf for fresh water to 64 pcf for sea water.
$[\epsilon]$	Unit strain in general.
$[\epsilon]+a$,	Axial strain in triaxial shear test.
$[W-DELTA]e$	Change in void ratio corresponding to a change in effective stress,
$[W-DELTA]p$. conditions	Magnitude of settlement for various conditions
$[\delta]$, $[\delta]+v$, $[\delta]+c$,	
$[\phi]$	Angle of internal friction or "angle of shearing resistance," obtained from Mohr's failure envelope for shear strength.
$[\sigma]$	Total major principal stress.

$[\sigma]_3$	Total minor principal stress
$[\sigma]^*$	Effective major principal stress
$[\sigma]_3$	Effective minor principal stress.
$[\sigma]_x$, directions. $[\sigma]_y$, $[\sigma]_z$,	Normal stresses in coordinate
$[\tau]$	Intensity of shear stress.
$[\tau]_{MAX}$	Intensity of maximum shear stress.
$[\nu]$	Poisson's Ratio